

AVISTAR™

AVISTAR

30cc

INSTRUCTION MANUAL



SPECIFICATIONS

Wingspan:	90.5 in [2300 mm]	Weight:	16.5 – 17.5 lbs [7482 – 7935 g]	Radio:	4 – 11 Channel
Length:	77.25 in [1962 mm]	Wing Loading:	26 – 28 oz/ft ² [79 – 85 g/dm ²]	Engine:	1.8 – 2.0 cu in [30 – 35 cc]
Wing Area:	1448 in ² [93.4 dm ²]			Electric:	RimFire 1.60 (63-62-250) Brushless

WARRANTY

Great Planes® Model Manufacturing Co. guarantees this kit to be free from defects in both material and workmanship at the date of purchase. This warranty does not cover any component parts damaged by use or modification. **In no case shall Great Planes' liability exceed the original cost of the purchased kit.** Further, Great Planes reserves the right to change or modify this warranty without notice.

In that Great Planes has no control over the final assembly or material used for final assembly, no liability shall be assumed nor accepted for any damage resulting from the use by the user of the final user-assembled product. By the act of using the user-assembled product, the user accepts all resulting liability.

If the buyer is not prepared to accept the liability associated with the use of this product, the buyer is

advised to return this kit immediately in new and unused condition to the place of purchase.

To make a warranty claim send the defective part or item to Hobby Services at the address below:

Hobby Services

3002 N. Apollo Dr. Suite 1
Champaign IL 61822 USA

Include a letter stating your name, return shipping address, as much contact information as possible (daytime telephone number, fax number, e-mail address), a detailed description of the problem and a photocopy of the purchase receipt. Upon receipt of the package the problem will be evaluated as quickly as possible.

READ THROUGH THIS MANUAL BEFORE STARTING CONSTRUCTION. IT CONTAINS IMPORTANT INSTRUCTIONS AND WARNINGS CONCERNING THE ASSEMBLY AND USE OF THIS MODEL.



Champaign, Illinois
(217) 398-8970, Ext 5
airsupport@greatplanes.com

TABLE OF CONTENTS

INTRODUCTION	2	CHOKE CONTROL	26
SAFETY PRECAUTIONS	2	Manual Choke Control	26
DECISIONS YOU MUST MAKE	3	Servo Controlled Choke	26
Engine Recommendations	3	Assemble the Fuel Tank	26
Motor Recommendations	3	Install the Fuel Tank	27
Radio Equipment	3	Install the Cowl	28
S.BUS QUICK START	5	ASSEMBLE THE FORWARD HATCH	28
ADDITIONAL ITEMS REQUIRED	6	Apply the Decals	29
Required Hardware and Accessories	6	GET THE MODEL READY TO FLY	30
Adhesives and Building Supplies	6	Check the Control Directions	30
Covering Tools	6	Set the Control Throws	30
Optional Supplies and Tools	7	Install the Propeller	31
IMPORTANT BUILDING NOTES	7	Balance the Model Laterally	32
KIT INSPECTION	7	Balance the Model (C.G.)	32
ORDERING REPLACEMENT PARTS	7	PREFLIGHT	33
KIT CONTENTS	8	Identify Your Model	33
PREPARATIONS	8	Charge the Batteries	33
ASSEMBLE THE WING	8	Ground Check and Range Check	33
Aileron Servo Installation	8	ENGINE SAFETY PRECAUTIONS	33
Flap Servo Installation (Optional)	11	ELECTRIC MOTOR SAFETY PRECAUTIONS	34
ASSEMBLE THE FUSELAGE	13	AMA SAFETY CODE (excerpts)	34
Install the Tail	13	General	34
Install the Main Landing Gear	14	Radio Control	34
Install the Tail Gear	15	FLYING	35
Install the Optional Trike Gear	17	Fuel Mixture Adjustments	35
Install the Rudder & Elevator Servos	18	Takeoff	35
Nose Gear Steering (for optional nose gear)	20	Flight	35
Electric Motor Installation	21	Landing	35
Gas Engine Installation	23		

INTRODUCTION

Continuing with the success of the Avistar line, Great Planes brings you the Avistar 30cc ARF. This is a great first gas powered model. The optional flaps allow you to add the flaps later if you desire. An optional float set (GPMA1676) is also available. We believe you will be very pleased with the ease of assembly and flight performance of the Avistar 30cc ARF.

For the latest technical updates or manual corrections to the Avistar 30cc ARF visit the Great Planes web site at www.greatplanes.com. Open the "Airplanes" link, then select the Avistar 30cc ARF. If there is new technical information or changes to this model a "tech notice" box will appear in the upper left corner of the page.

If you are not already a member of the AMA, please join! The AMA is the governing body of model aviation and membership provides liability insurance coverage, protects modelers' rights and interests and is required to fly at most R/C sites.

Academy of Model Aeronautics

5151 East Memorial Drive
Muncie, IN 47302-9252

Tele. (800) 435-9262
Fax (765) 741-0057



Or via the Internet at: <http://www.modelaircraft.org>

IMPORTANT!!! Two of the most important things you can do to preserve the radio controlled aircraft hobby are to avoid flying near full-scale aircraft and avoid flying near or over groups of people.

SAFETY PRECAUTIONS

Protect Your Model, Yourself & Others... Follow These Important Safety Precautions

1. Your Avistar 30cc ARF should not be considered a toy, but rather a sophisticated, working model that functions very much like a full-size airplane. Because of its performance capabilities, the Avistar 30cc ARF, if not assembled and operated correctly, could possibly cause injury to yourself or spectators and damage to property.
2. You must assemble the model **according to the instructions**. Do not alter or modify the model, as doing so may result in an unsafe or unflyable model. In a few cases the instructions may differ slightly from the photos. In those instances the written instructions should be considered as correct.
3. You must take time to **build straight, true and strong**.
4. You must use an R/C radio system that is in good condition, a correctly sized engine, and other components as specified in this instruction manual. All components must be correctly installed so that the model operates

correctly on the ground and in the air. You must check the operation of the model and all components before **every** flight.

5. If you are not an experienced pilot or have not flown this type of model before, we recommend that you get the assistance of an experienced pilot in your R/C club for your first flights. If you're not a member of a club, your local hobby shop has information about clubs in your area whose membership includes experienced pilots.
6. While this ARF has been flight-tested to exceed normal use, if an engine larger than one in the recommended range is used, the modeler is responsible for taking steps to reinforce the high stress points and/or substituting hardware more suitable for the increased stress.
7. **WARNING:** The cowl and wheel pants included in this ARF are made of fiberglass, the fibers of which may cause eye, skin and respiratory tract irritation. Never blow into a part to remove fiberglass dust, as the dust will blow back into your eyes. Always wear safety goggles, a particle mask and rubber gloves when grinding, drilling and sanding fiberglass parts. Vacuum the parts and the work area thoroughly after working with fiberglass parts.
8. **WARNING:** If you are building this plane as electric powered, set the failsafe on your transmitter so that the motor is off if the signal is lost and follow the safety precautions in the back of the manual.

We, as the ARF manufacturer, provide you with a top quality, thoroughly tested ARF and instructions, but ultimately the quality and flyability of your finished model depends on how you assemble it; therefore, we cannot in any way guarantee the performance of your completed model, and no representations are expressed or implied as to the performance or safety of your completed model.

REMEMBER: Take your time and follow the instructions to end up with a well-built model that is straight and true.

DECISIONS YOU MUST MAKE

This is a partial list of items required to finish the Avistar 30cc ARF that may require planning or decision making before starting to build. Order numbers are provided in parentheses.

Engine Recommendations

The recommended engine size range for the Avistar 30cc ARF is a 30 – 35cc [1.8 – 2.0 ci] two-stroke gasoline engine. We used the DLE-30, DLE-35RA and O.S. 33GT engines. Other engines can also be used but you may need to make modifications for mounting them.

- DLEG0031 DLE-30 requires (4) 10-32 x 1-1/4" (32 mm) socket head cap screws
- DLEG0435 DLE-35RA requires (4) 10-32 x 1-1/4" (32 mm) socket head cap screws
- OSMG1533 O.S. GT33 requires (4) 2" (50.8 mm) standoff (OSMG8962)

Motor Recommendations

- Great Planes RimFire 1.60 [63-62-250] Outrunner Brushless Motor (GPMG4795)
- Great Planes SS-60 ESC (GPMM1850)
- Spinner Adapter Kit (GPMQ4589)
- Great Planes Series Connector (GPMM3143)
- Two 5S FlightPower LiPo FP50 5000 mAh 18.5V Batteries (FPWP5505)
- XOAR 18x8 Electric Prop (XOAQ4079) Or APC 18 x 8 Electric Prop (APCQ4021)

OR

- Two 4S FlightPower LiPo FP50 5000 mAh 14.8V Batteries (FPWP5504)
- XOAR 20x10 Electric Prop (XOAQ4096) or APC 20 x 10 Electric Prop (APCQ4028)

Radio Equipment

The radio installation for the Avistar 30cc ARF can be achieved using three different radio set-ups: a Basic Radio Set-up, an Advanced Set-up and the S.Bus System Set-up.

BASIC RADIO SET-UP

The Basic Radio Set-up uses a 7-channel receiver (Futaba R617FS FUTL7627) connecting the two aileron servos with a Y-harness, two flap servos with a Y-harness and the two elevator servos with a Y-harness. The Y-harnesses are then plugged into the receiver. The rudder, throttle and optional choke servos are also plugged into the appropriate channels in the receiver. If the optional floats are installed, the float servos are connected to the rudder servo with a Y-harness.

RECOMMENDED SERVOS: All control surfaces require the use of a high-quality servo of at least 80 oz-in of torque. A servo of 30 oz-in of torque can be used for the throttle and choke.

FUNCTION	#	MINIMUM TORQUE	SUGGESTED SERVO
ELEVATORS	2	85 oz-in	Futaba S3305 FUTM0045
RUDDER	1	85 oz-in	Futaba S3305 FUTM0045
AILERONS	2	85 oz-in	Futaba S3305 FUTM0045
OPTIONAL FLAPS	2	85 oz-in	Futaba S3305 FUTM0045
THROTTLE	1	34 oz-in	Futaba S3001 FUTM0029
OPTIONAL CHOKE	1	34 oz-in	Futaba S3001 FUTM0029
TOTAL	9 Servos		

Electric Motor Installation

- (2) 24" Servo extensions (TACM2721)
- (3) 16" Servo extensions (FUTM4145)
- (2) Y-harness (TACM2751) For Flaps and Ailerons
- (1) Additional Y-harness for Elevator (TACM2751) or (FUTM4135)
- (1) Heavy duty on/off switch (FUTM4385) or (TACM2760)
- (1) Charge Receptacle (ERNM3001)
- (1) 3200 mAh LiFe Receiver battery (HCAM6446)

Additional Items for Gas Installation

- (2) 6" Servo extensions (FUTM4140) (TACM2700)
- (1) Additional Y-harness for choke if using a 6-channel receiver
- (1) Heavy duty on/off switch (FUTM4385 or TACM2761)
- (1) 1300 mAh LiFe ignition battery (HCAM6411)

ADVANCED RADIO SET-UP

The Advanced Set-up has each servo plugged into the receiver on its own channel. The channels can then be mixed together using the transmitter. This method will require at least an 8-channel receiver. A 9-channel receiver if using the optional choke servo and 11-channels if the optional floats are installed.

- Futaba R6008HS 8-channel FASST Receiver (FUTL7639)
- Futaba R6014HS 14-channel FASST Receiver (FUTL7645)
- The same servos used in the Basic Radio Set-up

Electric Motor Installation

- (2) 24" Servo Extension (Ailerons) (TACM2720)
- (3) 16" Servo Extension (ESC and Flaps) (FUTM4145)
- (4) 12" Servo Extension (Aileron and Flaps receiver connection) (TACM2710)
- (3) 6" Servo Extension (Rudder and Elevators) (FUTM4140) (TACM2700)
- (1) Heavy Duty on/off switch (FUTM4385) (TACM2760)
- (1) Charge Receptacle (ERNM3001)
- (1) 3200mAh LiFe Receiver battery (HCAM6446)

Additional Items for Gas Installation

- (2) 6" Servo Extension (Throttle and Choke) (FUTM4140) (TACM2700)
- (1) Additional Y-harness for the choke if using a 6-channel receiver
- (1) Heavy Duty on/off switch (FUTM4385) (TACM2760)
- (1) 1300mAh LiFe ignition battery (HCAM6411)

S.BUS SYSTEM SET-UP

A Cutting Edge Alternative to Standard Servo Installation!

The innovative Futaba S.Bus system lets you unleash your flight system's full potential and cut down on cable clutter at the same time. It uses digital serial data communication

technology to transmit control signals between your receiver and servos. A single S.Bus cable can carry signals to as many channels as your transmitter can handle. You no longer have to worry about plugging in the wrong servo to the wrong channel, because each servo knows what channel it is dedicated to in advance.

SBD-1 S.Bus Decoder Cables allow the use of existing analog and digital servos, too. By providing today's pilots with tomorrow's technology, the Futaba S.Bus system is nothing short of revolutionary.

Installing the S.Bus System

Installation is actually simplified as compared to your normal system installation. Using the S.Bus system you plug a battery into the SBC-1 channel changing tool, using it to program which channel you want the servo to operate on.



Once programmed the servo will operate as required regardless of which lead it is plugged into. Do this for all of the servos that you want to operate on the S.Bus system. Install the servos in the airplane

and plug them into the S.Bus lead, piggybacking them one onto another. Once completed you plug one lead into the receiver for all of the servos and all of the servos will function as programmed. One lead operates up to 16 servos!



S.Bus leads are available in a number of different lengths to accommodate installation into any size airplane regardless of its complexity.



There are many choices for the S. Bus receivers; some are tiny 3 port receivers with others being up to 8 channels. The 8 channel inputs can be used as you would normally set up a model, allowing you to split the

model and have some of it set up as S.Bus while other servos are not using the S. Bus system. Something else to note is that some of the S. Bus servos and receivers are HV or High Voltage, meaning that you could run a straight 2S LiPo for your receiver battery.



Many servo choices are available for use in a wide variety and sizes of aircraft from micros to the largest models.

S.BUS SYSTEM

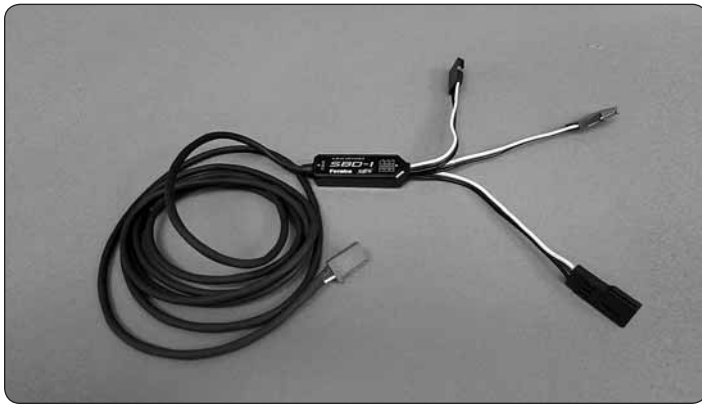
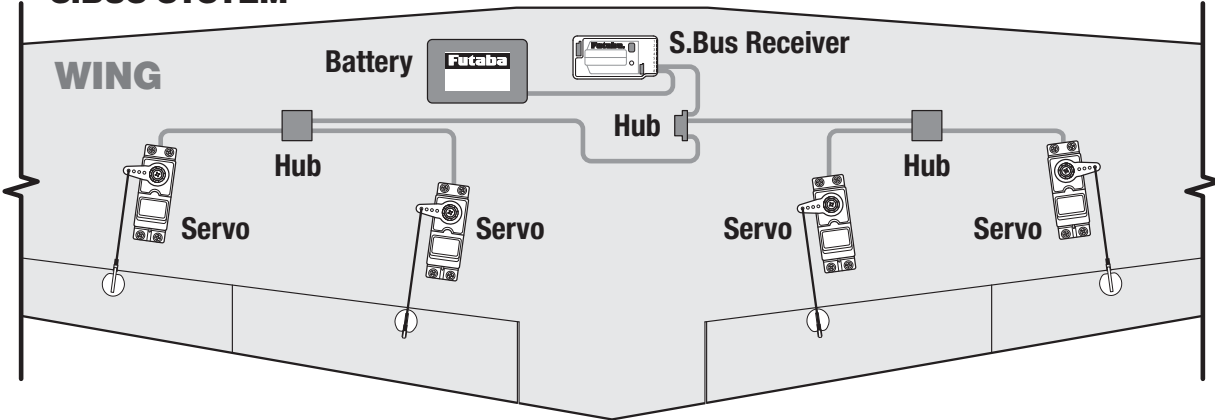

Your system is not limited to programming only through the SBC-1 channel changing tool and your transmitter. Utilizing the USB interface, the CIU-2, you can do all of the programming using your PC. Programming with this interface gives more flexibility and programming options than can be achieved with any other radio system. To utilize standard, non S.Bus servos, you simply use the S.Bus decoder instead of the S.Bus lead.

S.Bus Radio Equipment Recommendations

We will only set-up the wing with the S.Bus System. When installing the wing on the fuselage, this will reduce the number of servo leads to be connected to two. The same Futaba S3305 servos used in the wing for the Basic Set-up can still be used but will require two S.Bus Decoders.

- (1) S.Bus Receiver Futaba R6208SB (FUTL7668 (Works with the FASST-2.4GHz system)
- (1) S.Bus channel changer (FUTM4190) Required if your transmitter does not have an S.Bus Connector (check your transmitter instruction manual)
- The same servos used in the Basic Radio Set-up **and**
- (2) S.Bus Decoder SBD-1 (FUTM4192)

OR

- (4) Futaba S3070HV S.Bus servos (Ailerons and Flaps replacing four of the S3305 servos) (FUTM0716)
- (2) 6" Servo Extension (FUTM4140) (TACM2700)
- (2) 1000mm S.Bus Hub (FUTM4196)

Electric Motor Installation

- (1) S.Bus Servo Hub Cable 300mm (FUTM4195)
- (1) 16" Servo Extension (FUTM4145)
- (1) Y-harness for elevator (TACM2751) or (FUTM4135)
- (1) Heavy Duty on/off switch (FUTM4385) (TACM2760)
- (1) Charge Receptacle (ERNM3001)
- (1) 3200mAh LiFe Receiver battery (HCAM6446)

Additional Items for Gas Installation

- (2) 6" Servo Extension (Throttle and Choke) (FUTM4140) (TACM2700)
- (1) Additional Y-harness for the choke if using a 6-channel receiver
- (1) Heavy Duty on/off switch (FUTM4385) (TACM2760)
- (1) 1300mAh LiFe ignition battery (HCAM6411)

S.BUS QUICK START

Please read the instructions included with each S.Bus component for warnings and more detailed instructions.

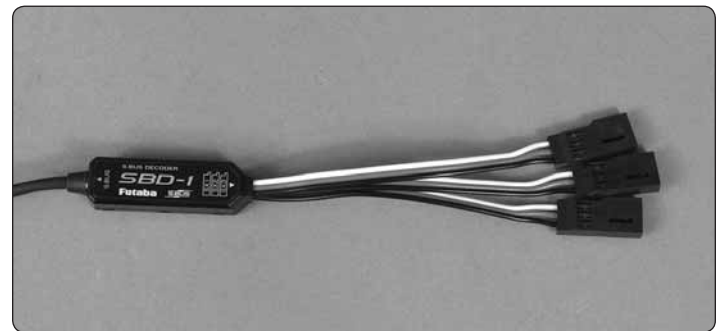

□ 1. If you are using a non S.Bus servo you will need to use an S.Bus decoder. The decoder has three servo connectors on it. You are going to use the S.Bus channel changer or S.Bus Connector on your transmitter to set the channel for each connector. If using your transmitter, follow the manual included with the transmitter for programming. If you are using S.Bus servos, the S.Bus decoder is not required. The servo can be connected directly into the channel changer.

□ 2. In this example, we are going to program the decoder connector SX1 to channel 1 for our aileron servo.



3. Connect the decoder to the S.Bus channel changer or plug in the S.Bus servo. Be sure to connect it to the S.Bus port.

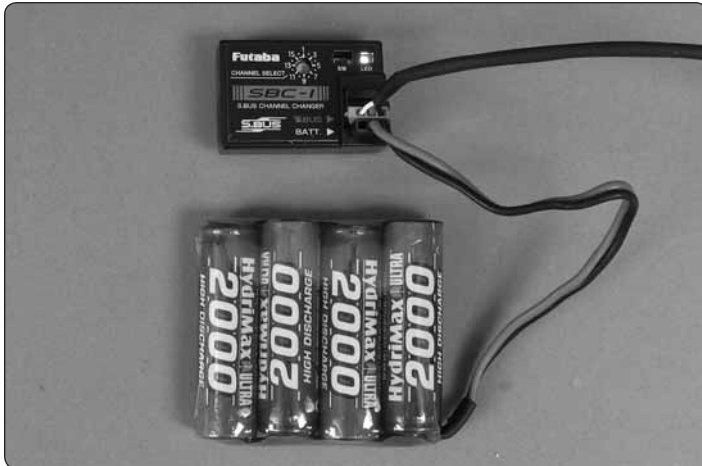

4. Connect a 4.8V battery to the S.Bus channel changer.



5. Note that the red LED is flashing. One flash per second is connector SX1. Press and release the set switch quickly and the light will flash two times per second for connector SX2. Press it again and it will flash 3 times per second for connector SX3. Set the channel changer to connector SX1. (One flash per second.)

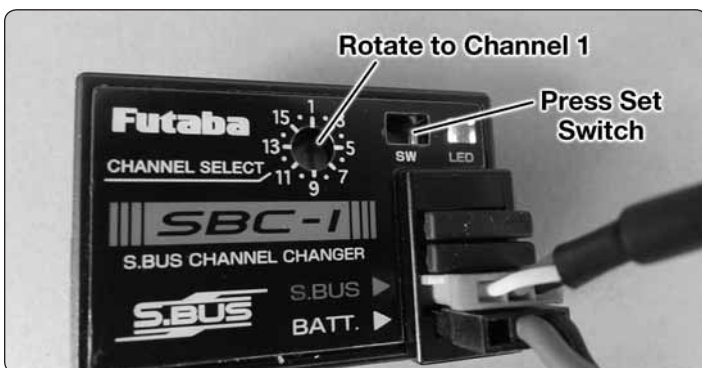

5. Use the plastic screw driver to rotate the dial to channel 1. Then press and hold the set switch. The red light will flash

quickly. When the red light stays on the decoder is set. Any servo plugged into connector SX1 will operate on channel 1. Place a ch1 label on the connector.

6. Follow the same procedure to set connector SX2 to channel 5 or the channel the flaps are set to on your transmitter.

ADDITIONAL ITEMS REQUIRED

Required Hardware and Accessories

- (1) Dubro #554 Large Tygon Fuel Line (DUBQ0427)
- (1) R/C Foam Rubber (1/4" [6mm], HCAQ1000; or 1/2" [13mm], HCAQ1050)
- Propeller and spare propellers suitable for your engine.
- Dubro #813 Fuel Line Barbs (DUBQ0670)

Adhesives and Building Supplies

This is the list of Adhesives and Building Supplies that are required to finish the Avistar 30cc ARF.

- 1/2 oz. [15g] Thin Pro CA (GPMR6001)
- Pro 30-minute epoxy (GPMR6047)
- Pro 6-minute epoxy (GPMR6045)
- Threadlocker thread locking cement (GPMR6060)
- Mixing sticks (50, GPMR8055)
- Mixing cups (GPMR8056)
- Epoxy brushes (6, GPMR8060)
- Denatured alcohol (for epoxy clean up)
- Masking tape
- Sandpaper
- Drill
- Drill bits: 1/16" [1.6 mm], 5/64" [2 mm], 5/32" [4 mm], 11/64" [4.5 mm], 3/16" [4.8 mm], 15/64" [6 mm], 1/4" [6.4 mm], 25/64" [10 mm]
- Small metal file
- Stick-on segmented lead weights (GPMQ4485)
- Silver solder w/flux (STAR2000)
- Hobbico 60 Watt Soldering Iron (HCAR0776)
- #1 Hobby knife (RMXR6903)
- #11 blades (5-pack, RMXR6930)
- Rotary tool such as Dremel®
- Rotary tool reinforced cut-off wheel (GPMR8200)
- DLE-30 Propeller Drill Guide (DLEQ0301)
- Canopy Glue Formula 560 (PAAR3300)

Covering Tools

- Top Flite® MonoKote® Sealing Iron (TOPR2100)
- Top Flite Hot Sock Iron Cover (TOPR2175)
- Top Flite MonoKote Trim Seal Iron (TOPR2200)
- Top Flite MonoKote Heat Gun (TOPR2000)
- Coverite® 21st Century® Sealing Iron (COVR2700)
- Coverite 21st Century Cover Sock (COVR2702)
- Coverite 21st Century Trim Sealing Iron (COVR2750)

Optional Supplies and Tools

Here is a list of optional tools mentioned in the manual that will help you build the Avistar 30cc ARF.

- 2 oz. [57g] spray CA activator (GPMR6035)
- CA applicator tips (HCAR3780)
- CA debonder (GPMR6039)
- 36" metal ruler
- Pliers with wire cutter (HCAR0625)
- Robart® Super Stand II™ (ROBP1402)
- Servo horn drill (HCAR0698)
- AccuThrow™ Deflection Gauge (GPMR2405)
- CG Machine™ (GPMR2400)
- Precision Magnetic Prop Balancer (TOPQ5700)

IMPORTANT BUILDING NOTES

- Anytime a sheet metal screw is installed in wood, first install the screw, remove the screw and apply a couple of drops of thin CA in the hole to harden the threads. After the CA has cured, reinstall the screw.
- Anytime a threaded screw or nut is installed, a drop of threadlocker must be applied to the threads. An exception, do not use threadlocker on the screws installed in the nylon control horns.
- Denatured alcohol is great for cleaning epoxy from surfaces before the epoxy cures.
- Replacement MonoKote colors:
 - Jet White (TOPQ0204) Metallic Gold (TOPQ0404)
 - Black (TOPQ0208) Sapphire Blue (TOPQ0226)

KIT INSPECTION

Before starting to build, inspect the parts to make sure they are of acceptable quality. If any parts are missing or are not of acceptable quality, or if you need assistance with assembly, contact **Product Support**. When reporting defective or missing parts, use the part names exactly as they are written in the Kit Contents list.

Great Planes Product Support

3002 N Apollo Drive, Suite 1 Ph: (217) 398-8970, ext. 5
 Champaign, IL 61822 Fax: (217) 398-7721

E-mail: airsupport@greatplanes.com

ORDERING REPLACEMENT PARTS

Replacement parts for the Great Planes Avistar 30cc ARF are available using the order numbers in the **Replacement Parts List** that follows. The fastest, most economical service can be provided by your hobby dealer or mail-order company. Not all parts are available separately (an aileron cannot be purchased separately, but is only available with the wing kit). Replacement parts are not available from Product Support, but can be purchased from hobby shops or mail order/Internet order firms. Hardware items (screws, nuts, bolts) are also available from these outlets.

To locate a hobby dealer, visit the Great Planes web site at **www.greatplanes.com**. Choose "Where to Buy". Follow the instructions provided on the page to locate a U.S., Canadian or International dealer.

REPLACEMENT PARTS LIST

Order No.	Description
GPMA2878	Tailwheel Assembly
GPMA4550	Wing Set
GPMA4551	Fuselage Set
GPMA4552	Tail Surface Set
GPMA4553	Canopy/Hatch
GPMA4554	Cowl
GPMA4555	Main Landing Gear
GPMA4557	Wing Joiner Tube
GPMA4558	Spinner
GPMA4559	Decals
GPMA4560	Main Gear Wheel Pants
GPMA4562	EP Motor Mount Box

Optional Parts

GPMA4556	Nose Gear
GPMA4561	Nose Gear Wheel Pants
GPMA4568	Nose Gear Assembly
GPMA4563	Float (1pc)
GPMA4564	Ventral Fin
GPMA4565	Float Mounting Set
GPMA4566	Water Rudder
GPMA4567	Glider Tow Release Set

KIT CONTENTS

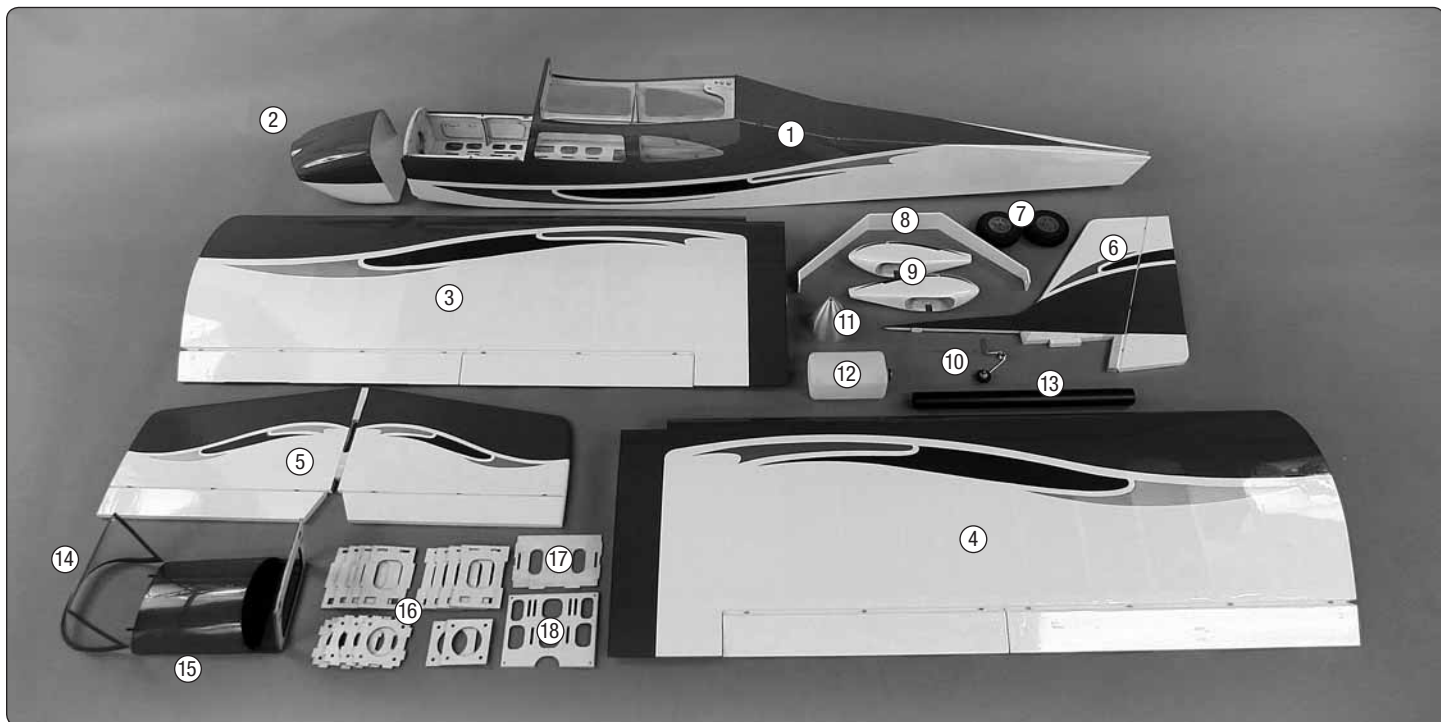

- | | | |
|--------------------------|----------------------|---|
| 1. Fuselage | 8. Main Gear | 15. Hatch |
| 2. Cowl | 9. Main Wheel Pants | 16. Motor Box (see parts list for break down) |
| 3. Left Wing Panel | 10. Tail Gear | 17. Receiver Tray |
| 4. Right Wing Panel | 11. Spinner | 18. Forward Battery Tray |
| 5. Horizontal Stabilizer | 12. Fuel Tank | |
| 6. Vertical Stabilizer | 13. Wing Joiner Tube | |
| 7. Main Wheels | 14. Wind Screen | |

The parts not shown are listed on page 36.

PREPARATIONS

1. Firmly pull on each of the control surfaces to confirm they are securely glued.

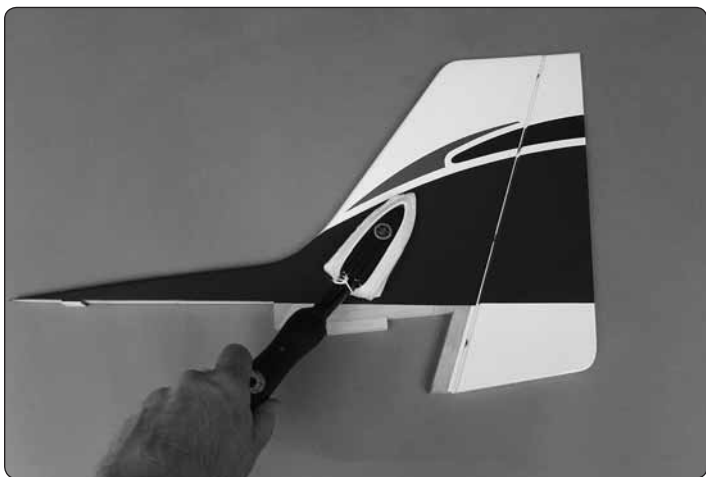

2. Tighten the covering with a covering iron as needed.

ASSEMBLE THE WING

Aileron Servo Installation

Begin with the left wing panel.

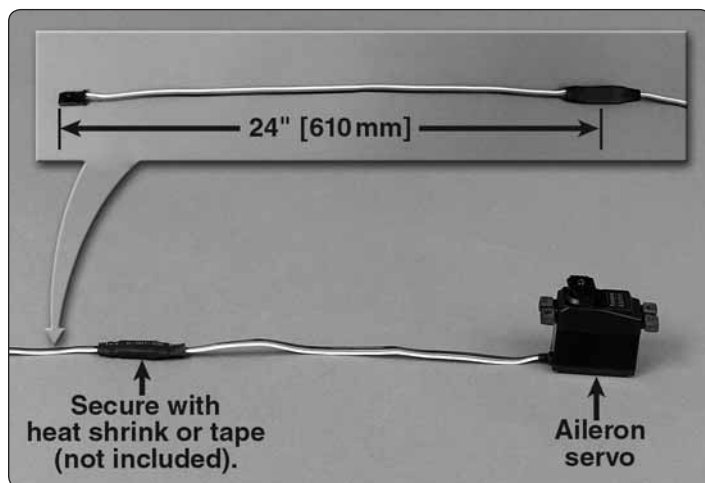

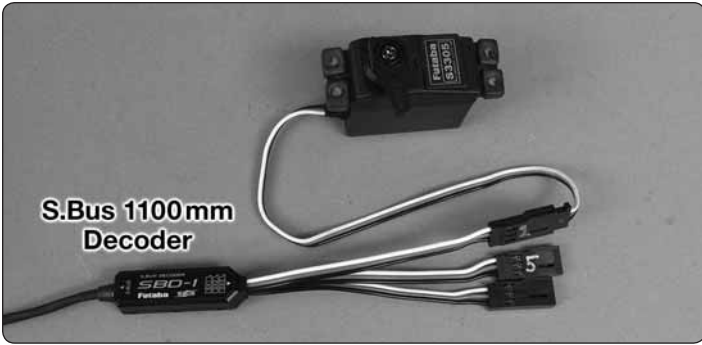

1. Install a servo lead extension or S.Bus 1100mm decoder on the S3305 servo or 6" extension and 1000mm S.Bus hub on the S.Bus S3070HV servo.

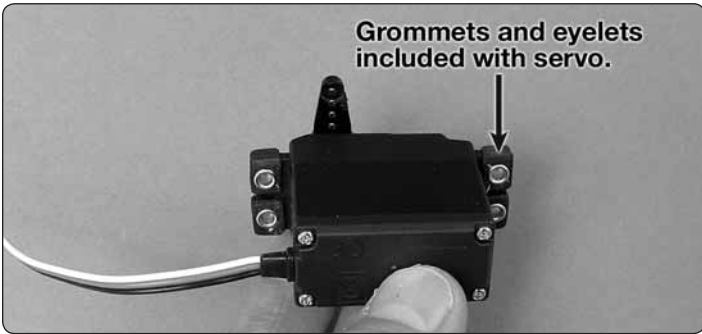

2. Install grommets and eyelets on all servos.

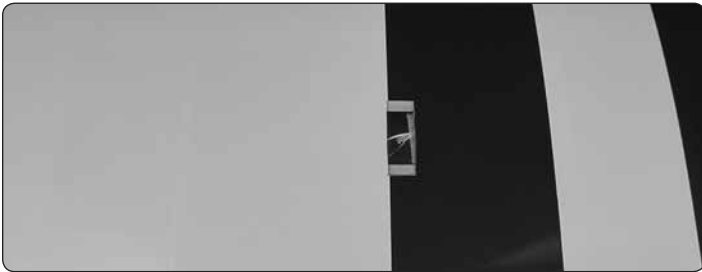

3. Trim the covering from over the aileron servo opening.

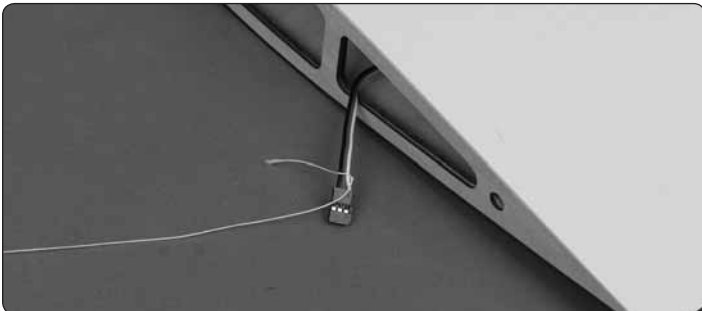
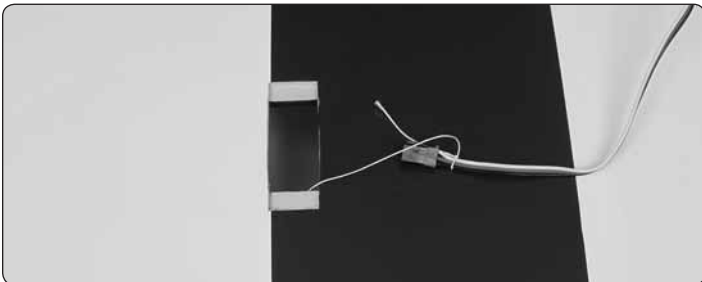

4. Route the servo lead or the decoder lead through the wing.

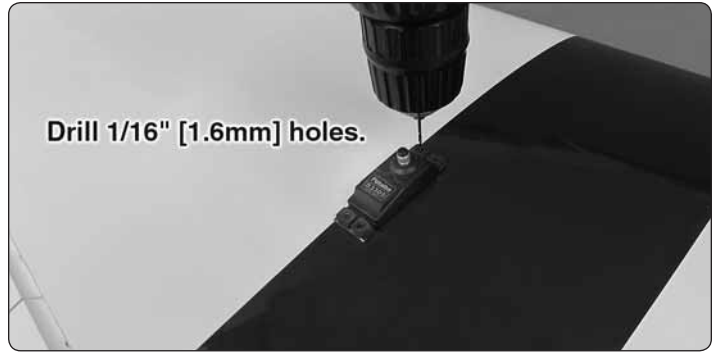

5. Drill servo screw mounting hole.



6. Install servo screws.

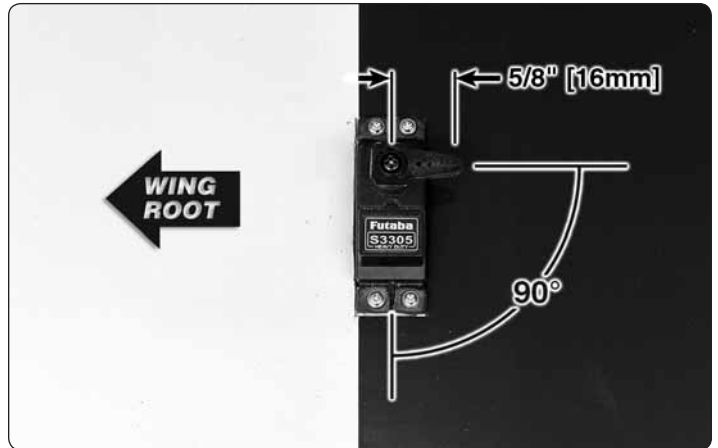

7. Connect the servo to the aileron channel on the receiver. If using S.Bus, plug the Decoder or Hub into the S.Bus port on the receiver. Switch on the transmitter and receiver and install the servo horn.

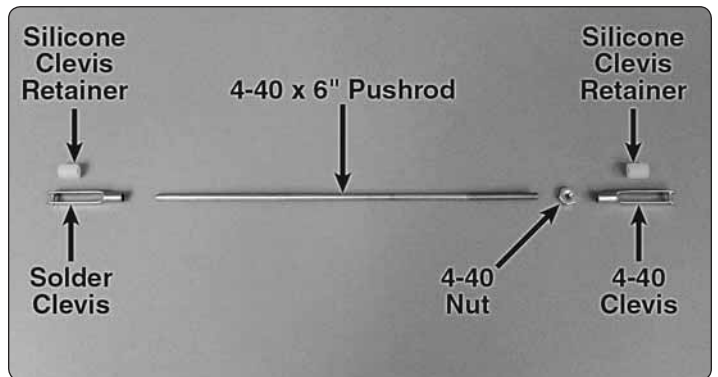

8. Aileron pushrod components.

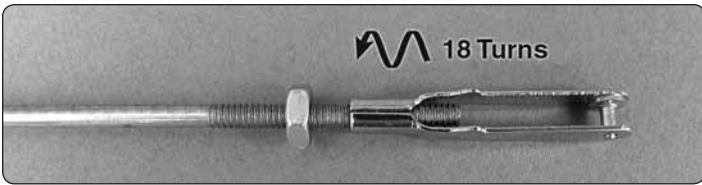

☐☐ 9. Install the 4-40 threaded clevis.

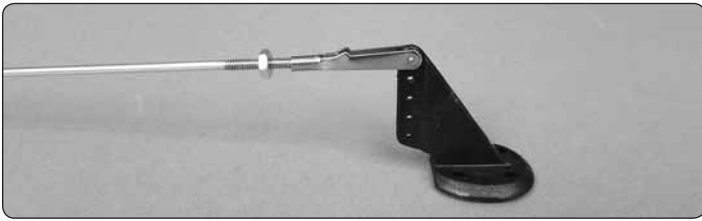

☐☐ 10. Attach clevis to control horn.

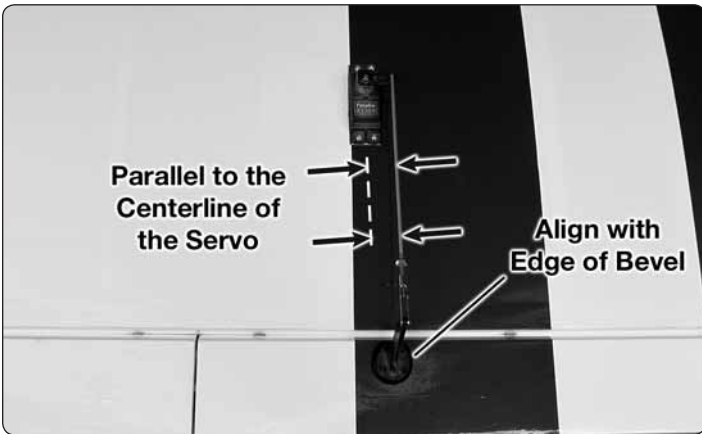

☐☐ 11. Position control horn on aileron.



☐☐ 12. Mount control horn.

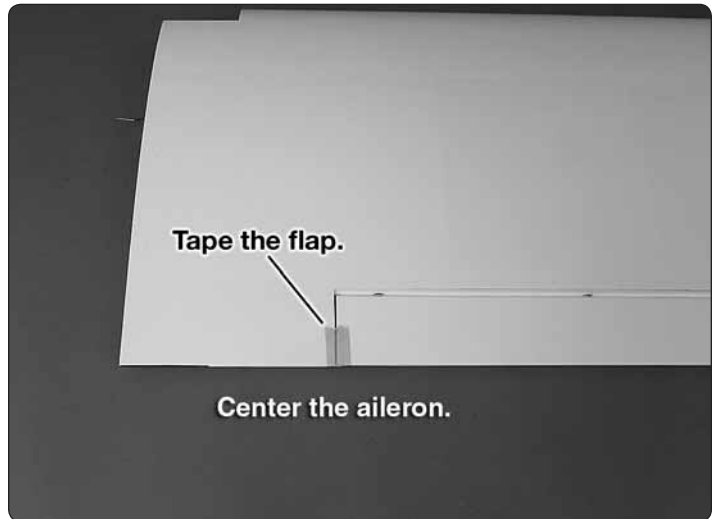

☐☐ 13. Install the solder clevis.

EXPERT TIP
EXPERT TIP

HOW TO SOLDER

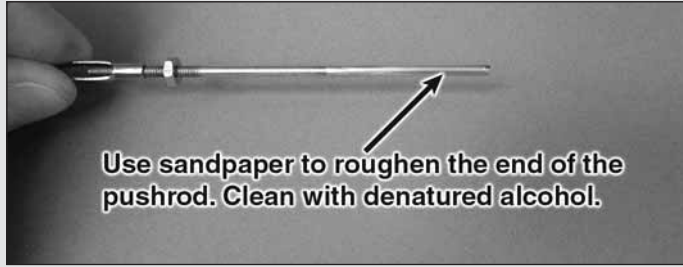

Apply a few drops of soldering flux to the end of the pushrod. "Tin" the end of the pushrod by applying heat. Apply silver solder to the heated area. The pushrod should melt the solder, not the flame of the torch. The end of the pushrod should be tinned all the way around.

Position the solder clevis on the pushrod and apply a drop of flux to the joint. Apply heat and add solder. Again, the heat of the part should melt the solder, not the flame of the torch. Allow the part to cool naturally. Make sure the joint is thoroughly soldered. It should be shiny, not rough. Reheat if necessary.

Wipe off the flux residue with denatured alcohol. Coat the joint with oil to prevent rust.

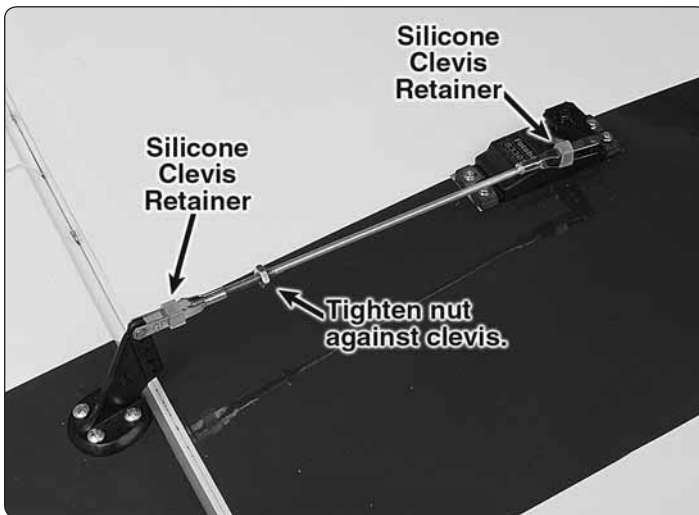
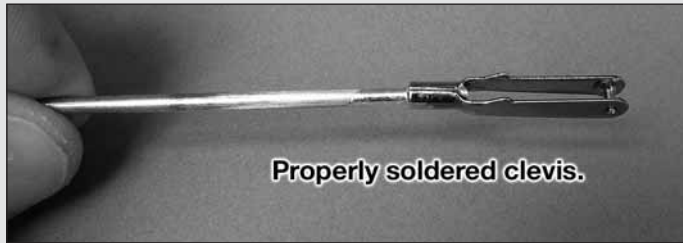

14. Reinstall the aileron pushrods and slide the retainers over the clevises.

15. Repeat steps 1 – 14 to install the aileron servo in the right wing.

Flap Servo Installation (Optional)

Flaps are not necessary to land the Avistar 30cc. However, if you have never flown with flaps, the Avistar 30cc is a great plane to learn with.

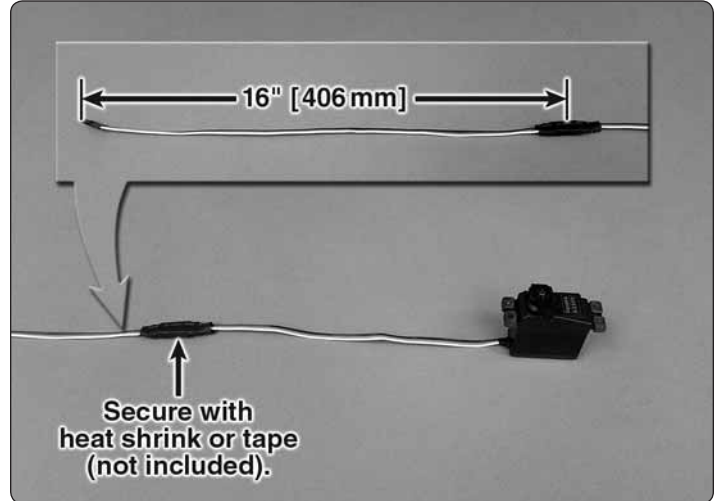

1. Install a servo lead extension on the flap servo. If using S.Bus, plug the servo into the S.Bus decoder or Hub. (Installed with the ailerons.)

2. Install grommets and eyelets in the flap servo .

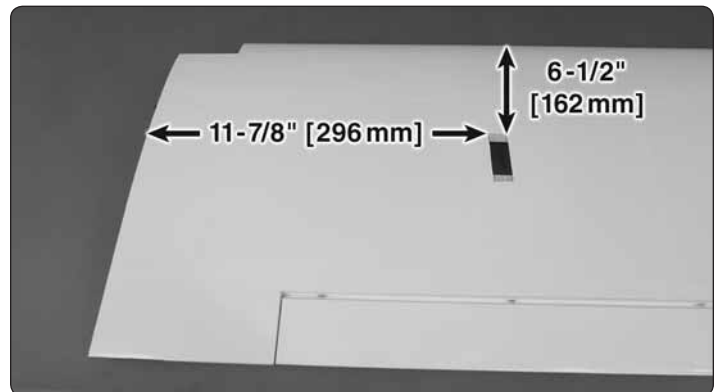

3. Remove the covering from flap servo opening.

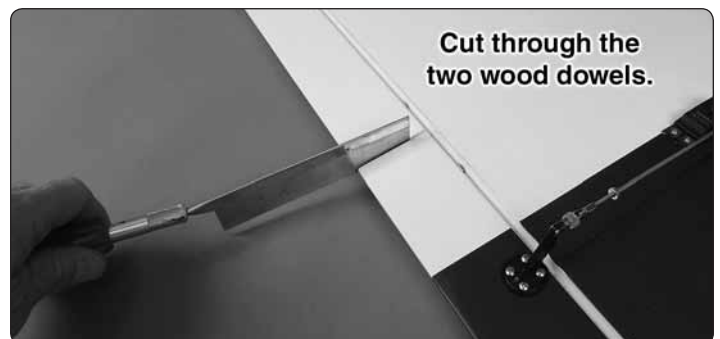

4. Separate the flap from the aileron.

5. Mount the flap servo in the wing. Route the servo lead to the root rib, or connect it to the S.Bus decoder.

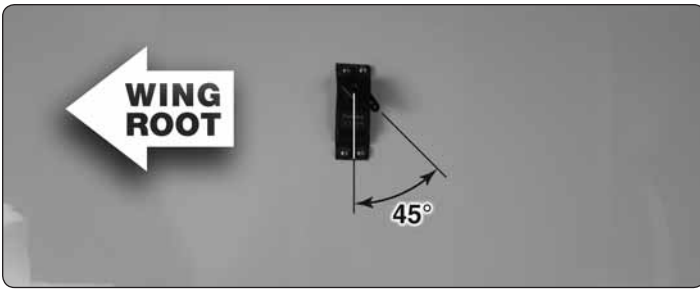

❑ 6. Plug the flap servo into the flap channel or the decoder hub into the S.Bus port on your receiver. Switch on your radio system and adjust the flap control so that the travel is at its end point. Install a servo arm on the flap servo so that it is approximately 45 degrees from the centerline of the servo.



❑ 7. Install the flap control horn following the same procedure used to install the aileron control horn.

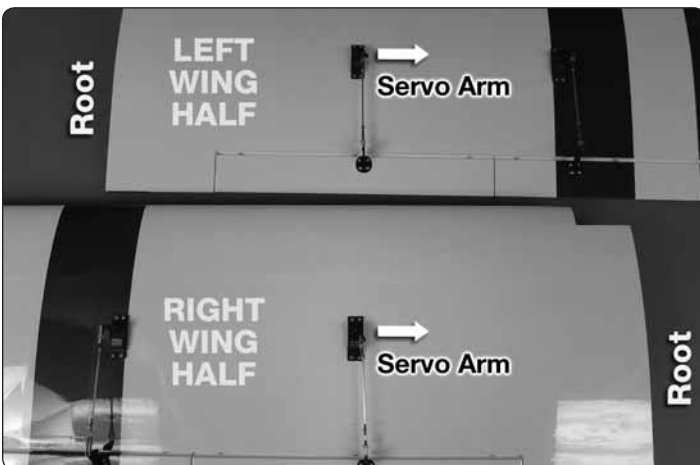

❑ 8. Install the flap servo in the right wing half. Note that the servo arm is on the wing root side of the servo.

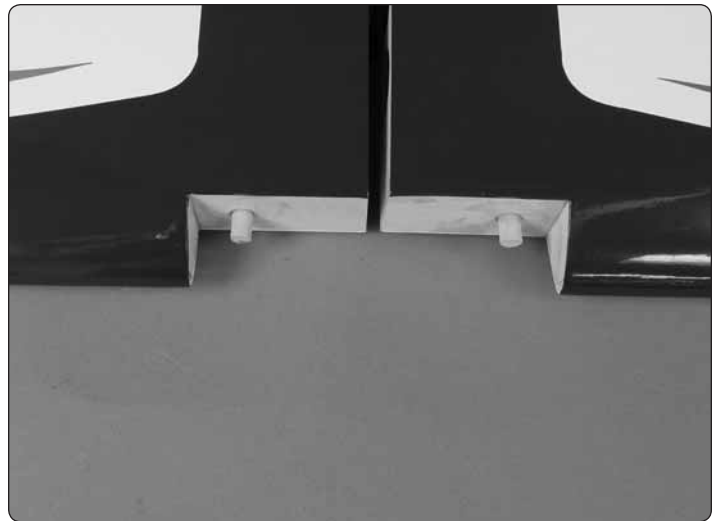

❑ 9. Use epoxy to glue the two 10 x 35mm hardwood wing dowels in the wing.

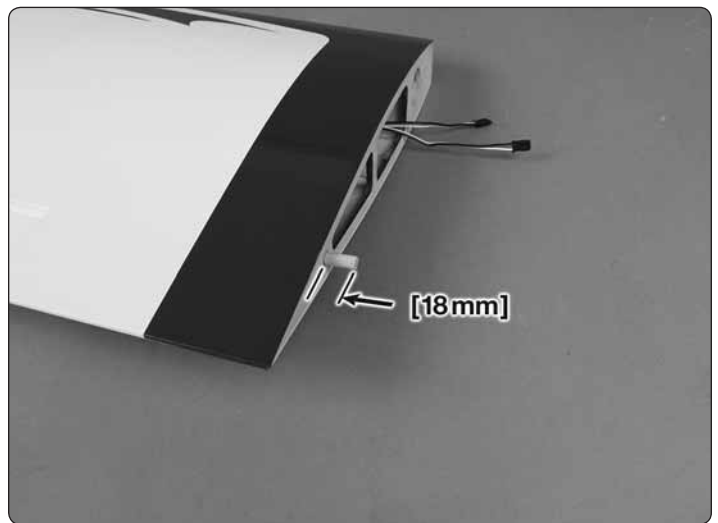

❑ 10. Use epoxy to glue the 8 x 35mm hardwood wing joiner dowel 18mm into the left wing root.

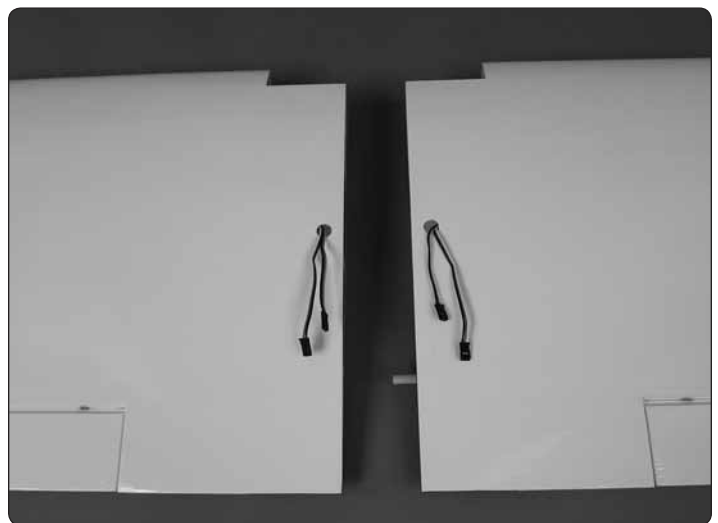

❑ 11. Trim the covering from over the exit holes and route the aileron and flap servo leads, S.Bus decoder, or hubs out the holes.

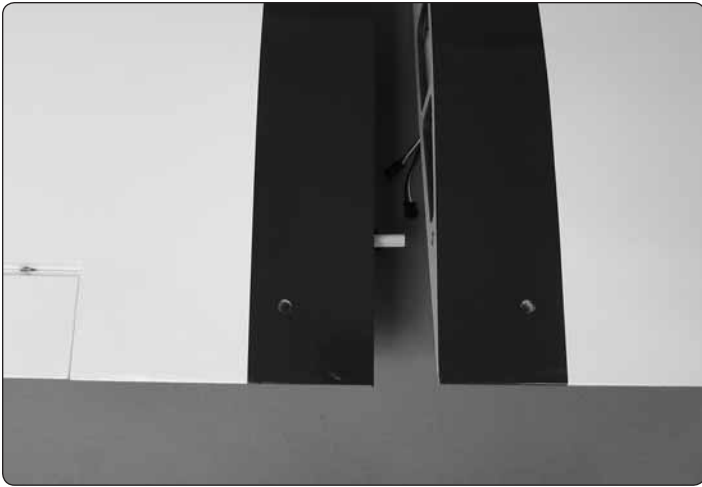

❑ 12. Trim the covering from over the wing bolt holes.

ASSEMBLE THE FUSELAGE

Install the Tail



❑ 1. Slide both wing halves onto the wing tube. Slide the wing halves together.



1/4-20 x 2" [50.1mm]
Nylon Wing Bolts

❑ 2. Install the wing on the fuselage.

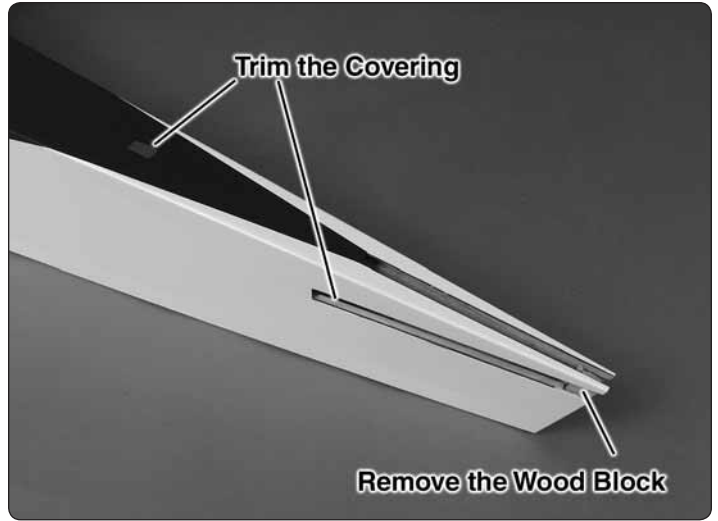

Trim the Covering

Remove the Wood Block

❑ 3. Trim the covering.

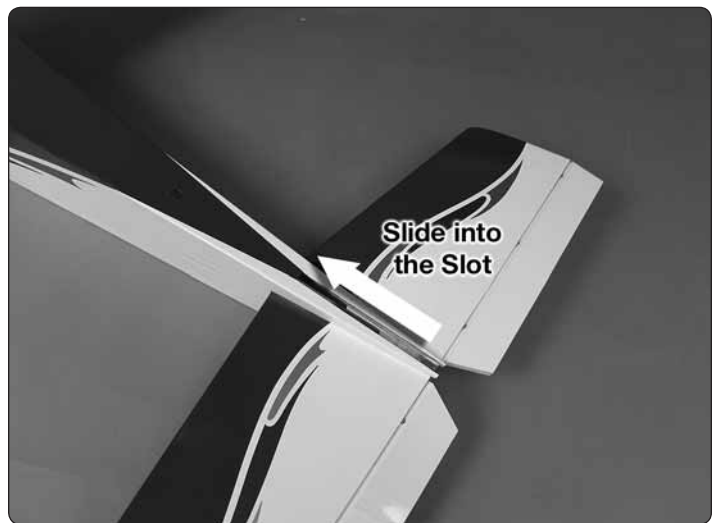

Slide into the Slot

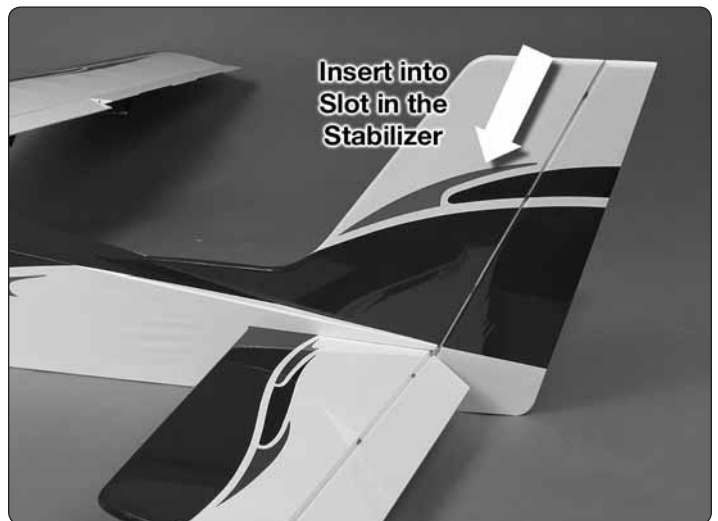

Insert into Slot in the Stabilizer

❑ 4. Temporarily install the horizontal stabilizer and the vertical fin.

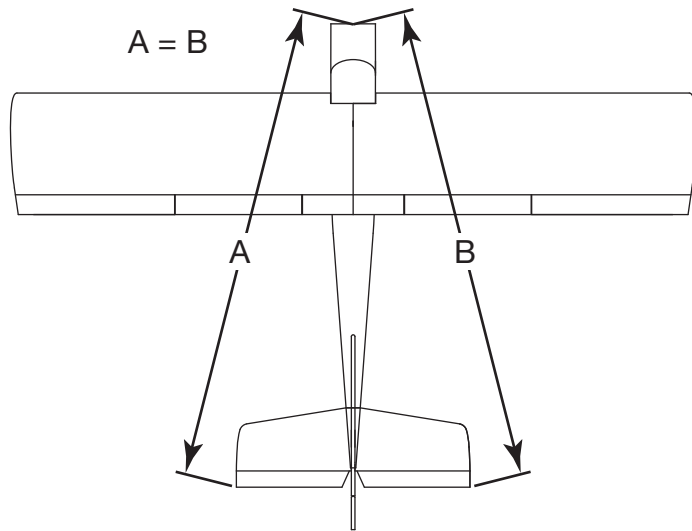

❑ 5. Check the alignment of the horizontal stabilizer. The distance from the center of the nose of the fuselage to the tips of the horizontal stabilizer should be equal.



❑ 6. The wing and the stabilizer should be parallel. If they are not, lightly sand the stabilizer slot.

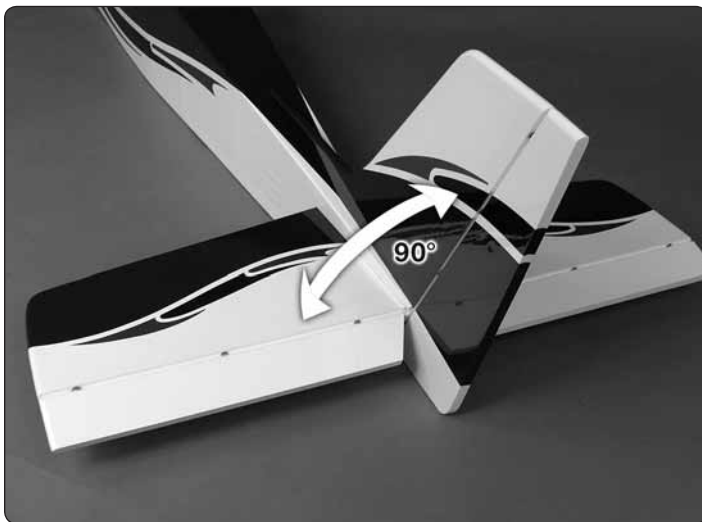

❑ 7. Use 30-minute epoxy to glue the stabilizer and fin in the fuselage. Clean off any excess epoxy with denatured epoxy and paper towels.

Install the Main Landing Gear

*If installing the optional floats (GPMA1676), skip to
Install the Rudder & Elevator Servos*

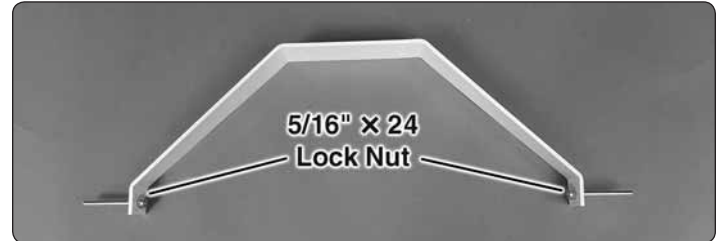

❑ 1. Install the 3/16" [4.8mm] axles.

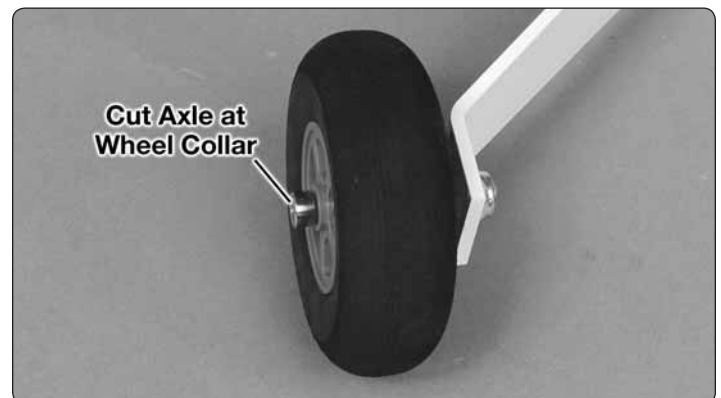

❑ 2. Cut the axle to length.



❑ 3. File a flat spot at the bottom end of the axle.

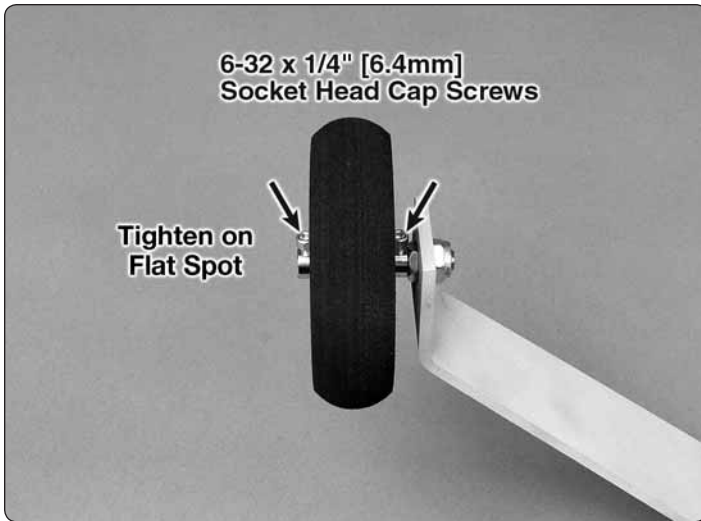

☐ 4. Install the main wheel.

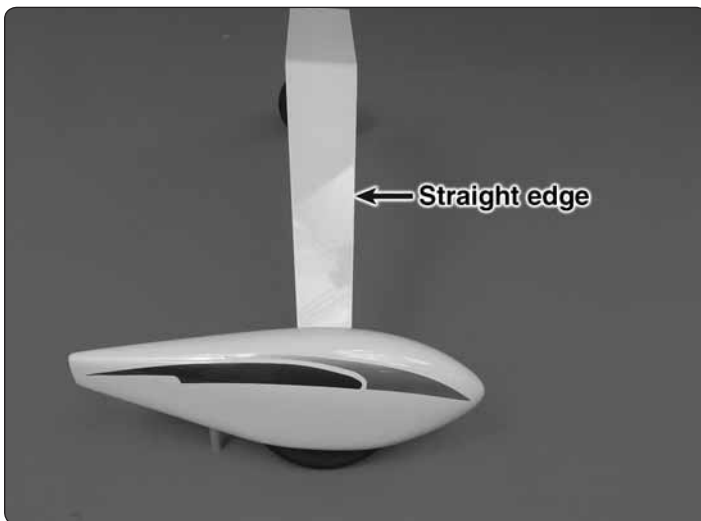

☐ 5. Install the wheel pants.

If the plane is being built as a tail dragger, install the main landing gear in the forward position. If the plane is being built as the optional trike gear, skip ahead to **Install the Optional Trike Gear**.



☐ 6. Install the main landing gear on the fuselage.

Install the Tail Gear

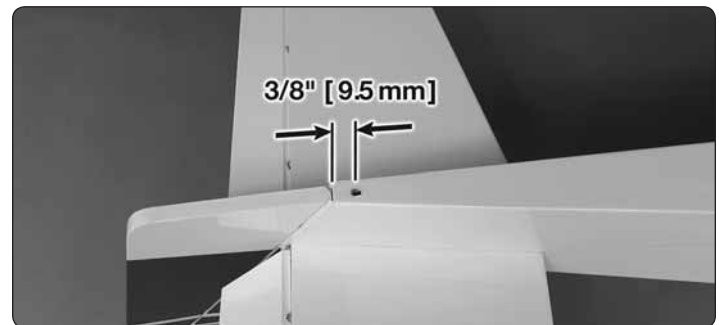

☐ 1. Drill a 15/64" [6mm] hole in the bottom of the fuselage.



☐ 2. Use 6-minute epoxy to glue the tail gear bearing in the fuselage.

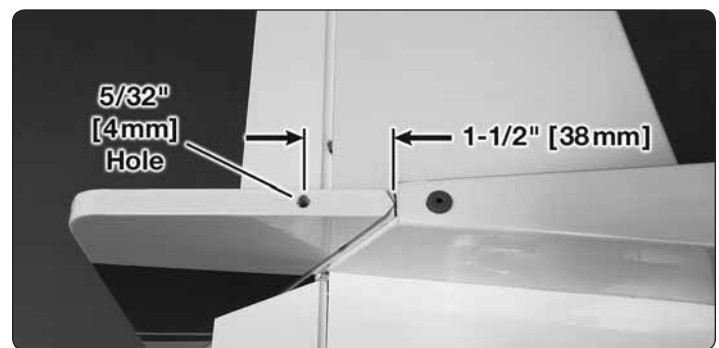

☐ 3. Drill a 5/32" [4mm] hole, 1-1/2" [38mm] aft of the rudder hinge line.

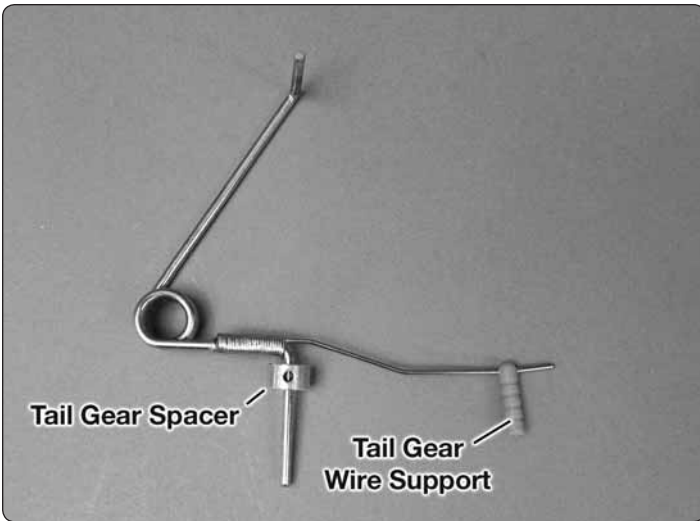

❑ 4. Slide the tail gear spacer and the tail gear wire support onto the tail gear wire.

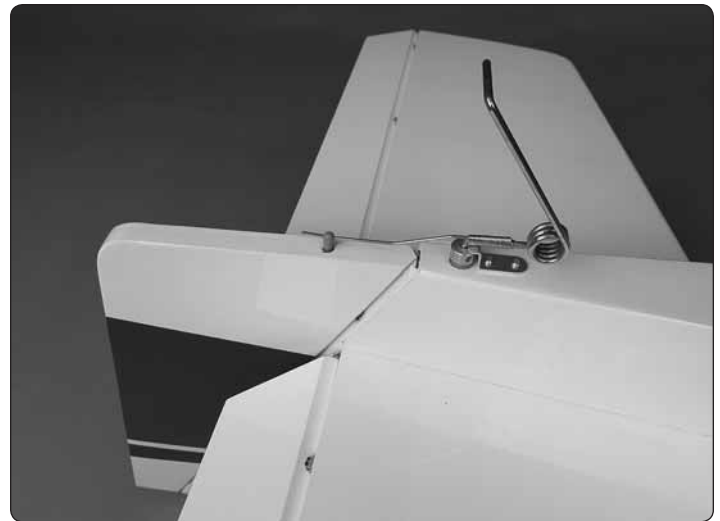

❑ 8. Apply 6-minute epoxy in the hole for the tail gear wire support. Before the epoxy cures, insert the support in the hole and the tail gear wire in the tail gear bearing. Attach the tail gear bracket to the fuselage with two #2 x 3/8" (9.5mm) sheet metal screws.



❑ 5. Test fit the tail gear wire assembly in the tail gear bearing.



❑ 9. Install and tighten the 3mm set screw in the tail gear spacer. Check that the rudder and tail gear move smoothly.

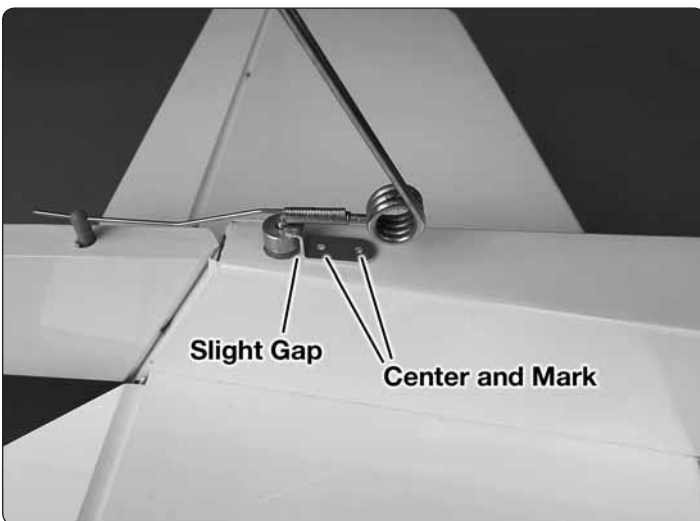

❑ 6. Position the tail gear bracket over the tail gear spacer. On the bottom of the fuselage, mark the two mounting hole locations.

❑ 7. Drill a 1/16" (1.5 mm) hole at each mark.



❑ 10. Install the tail wheel.

Install the Optional Trike Gear

(GPMA4568 and GPMA4561) (nose gear not included)



- ❑ 1. Install the main landing gear on the fuselage.



- ❑ 2. Remove the covering from over the nose gear wire exit.

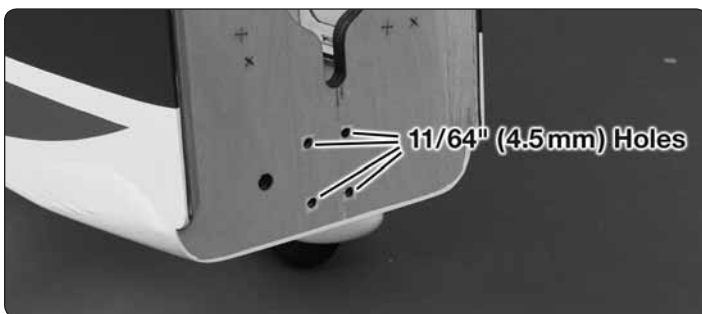

- ❑ 3. Drill 11/64" (4.5mm) holes at the four nose gear bearing marks.



- ❑ 4. Install the four 6-32 blind nuts in the front of the firewall. Apply a drop of glue to each nut to hold it secure.

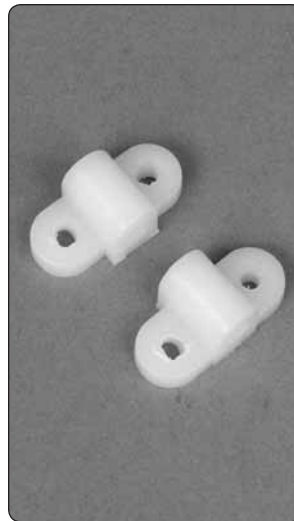

- ❑ 5. Separate the top and bottom of the nylon nose gear bearing. Install the nose gear bearing on the back side of the firewall. Before completely tightening the cap screws, insert the nose gear wire to align the nose gear bearing.

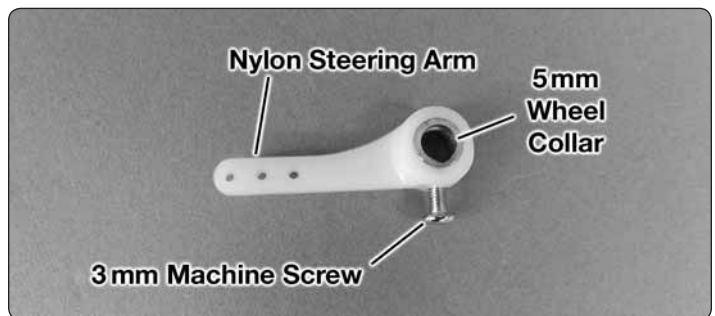

- ❑ 6. Assemble the nylon steering arm.

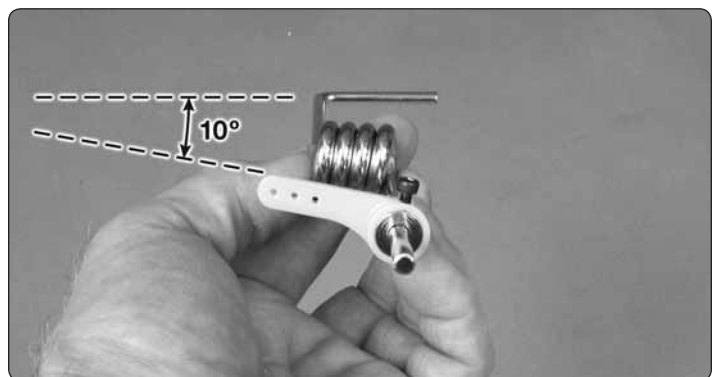
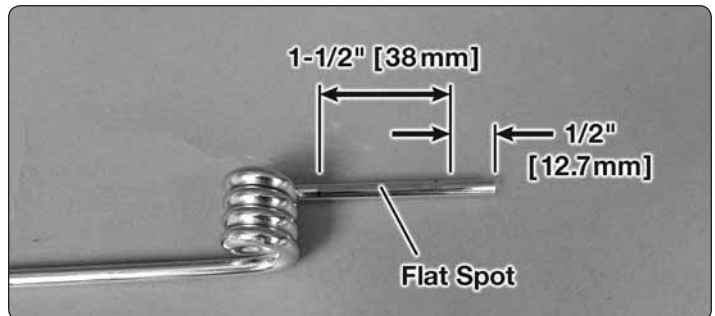

- ❑ 7. File a flat spot on the nose gear wire so that when the steering arm is installed it will be angled approximately 5 to 10 degrees from the axle.

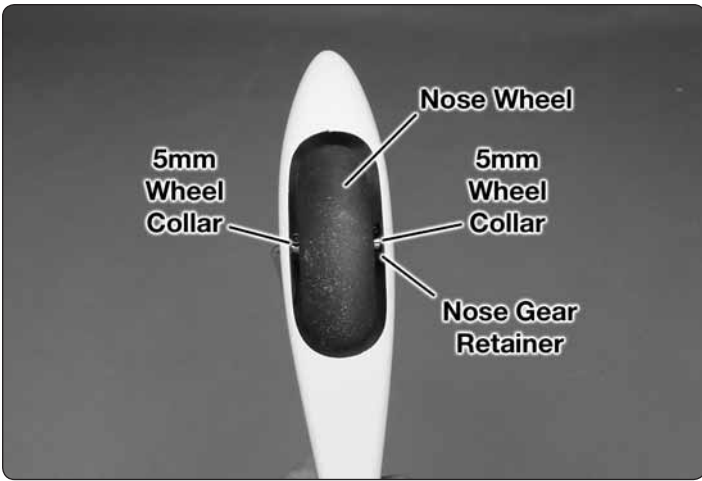

□ 8. Insert the nose gear wire in the nose gear wheel pant, through a 5mm wheel collar, the nose wheel, a second 5mm wheel collar and the nose gear retainer recess on the inside of the wheel pant. Secure the wheel collars with 3mm cap screws, making sure the nose wheel rotates freely.

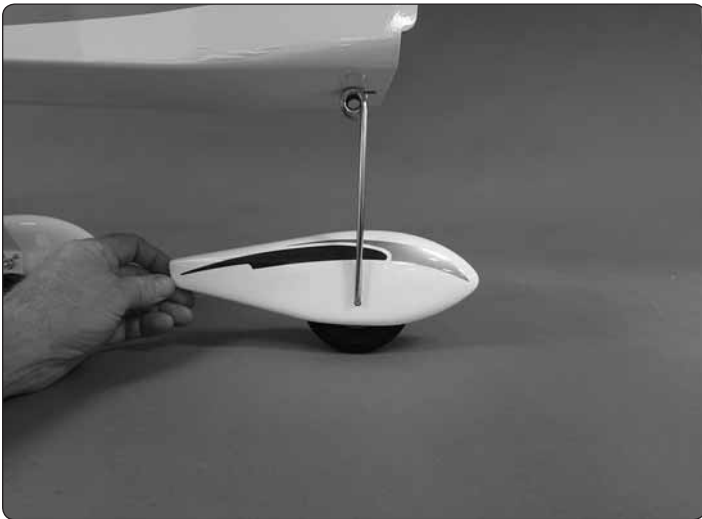

□ 9. Insert the nose gear into the nose gear bearing. Position the wheel pant and mark the location of the nose gear wire on the wheel pant.



□ 10. Drill 1/16" (1.6mm) holes and attach the landing gear straps.

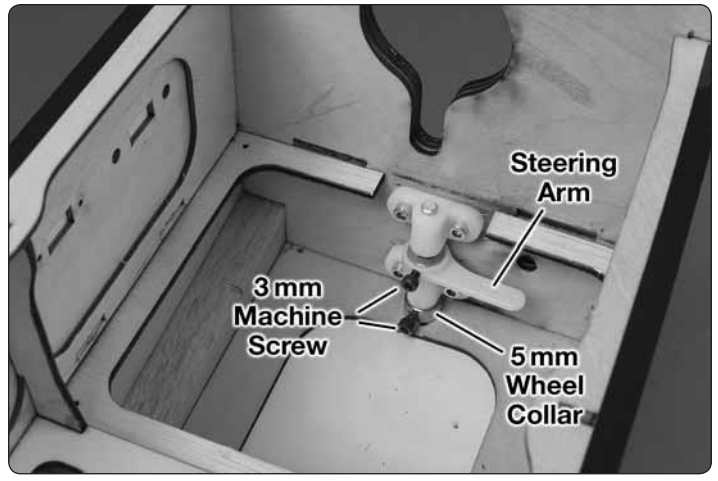

□ 11. Position a 5mm wheel collar under the nose gear bearing. Insert the nose gear wire through the wheel, the bottom nose gear bearing, the steering arm and the top nose gear bearing. Temporarily tighten the 3mm machine screws.

Install the Rudder & Elevator Servos

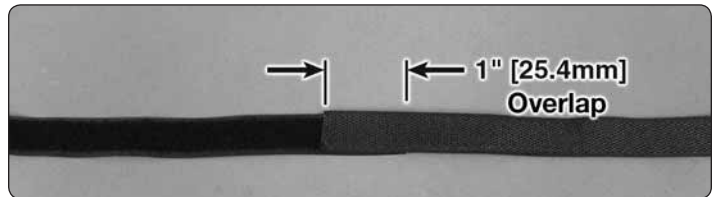

□ 1. Make a hook and loop strap.

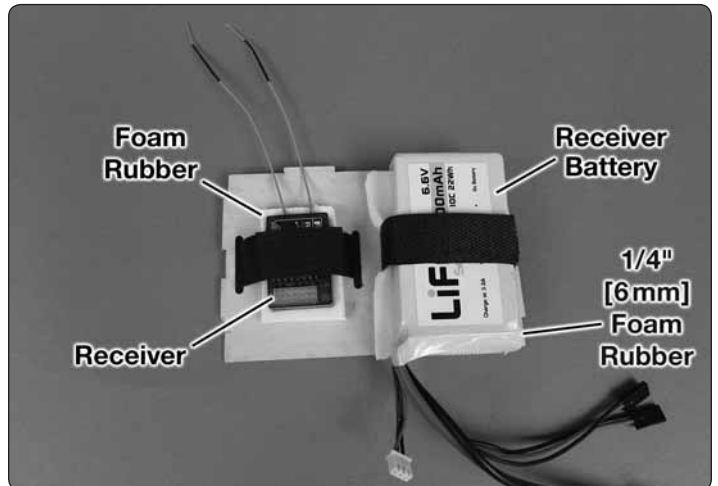

□ 2. Cut the hook and loop material to make two straps, one for the receiver and one for the receiver battery.

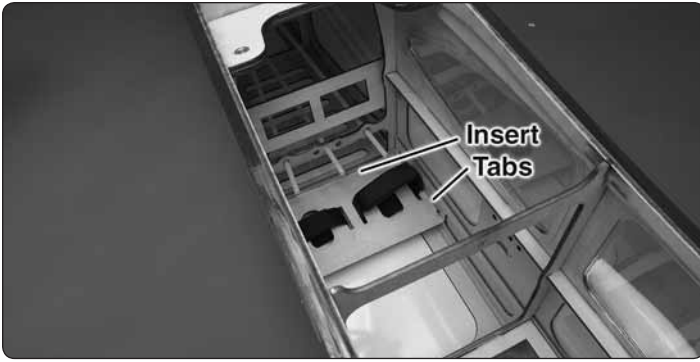

❑ 3. Securely glue the receiver/receiver battery tray in the fuselage.

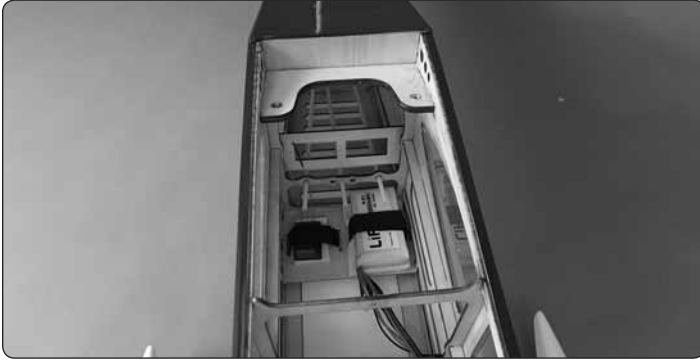

❑ 4. Install the receiver and receiver battery.

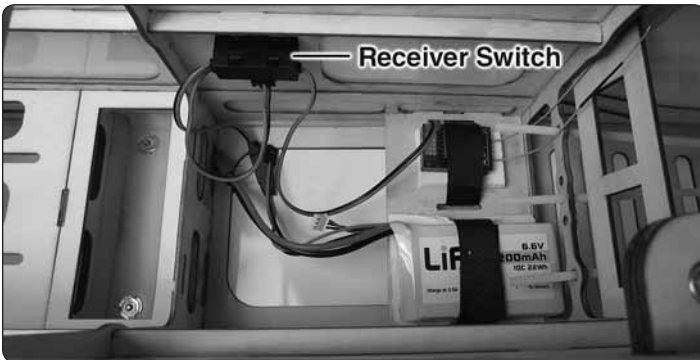

❑ 5. Install the receiver battery switch and charge recepticle. Connect the receiver battery to the switch and the switch to the receiver.

❑ 6. Insert a 4-40 x 48" metal pushrod into the middle pushrod tube.

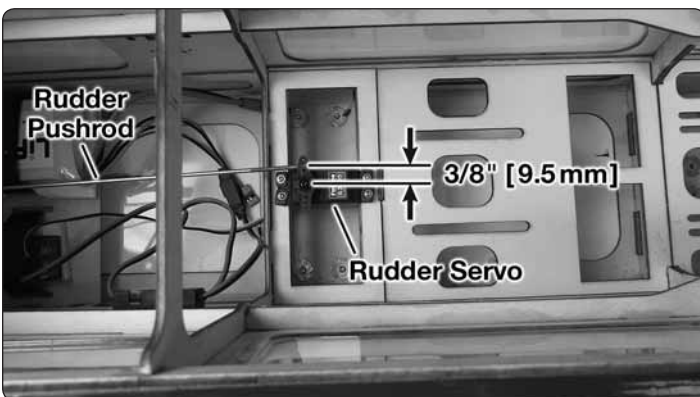

❑ 7. Install the rudder servo and plug it into the receiver.

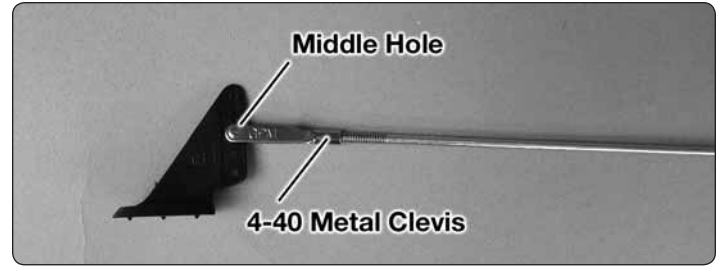

❑ 8. Install a 4-40 threaded clevis on the rudder pushrod. Attach the control horn.

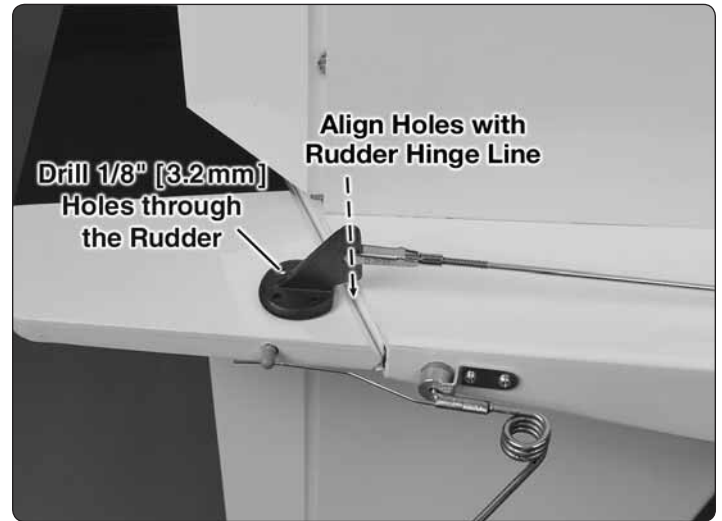

❑ 9. Position the rudder control horn.

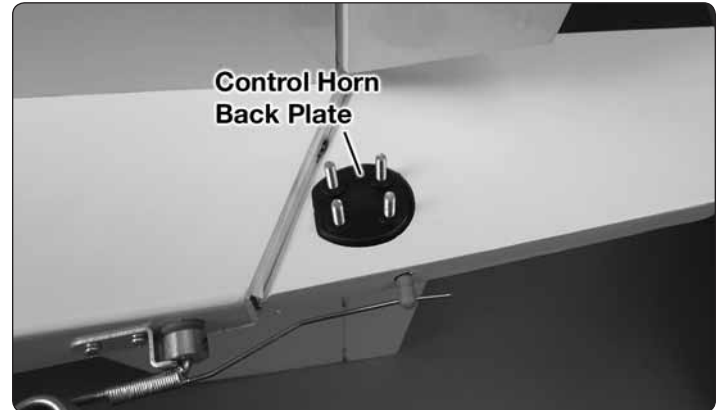
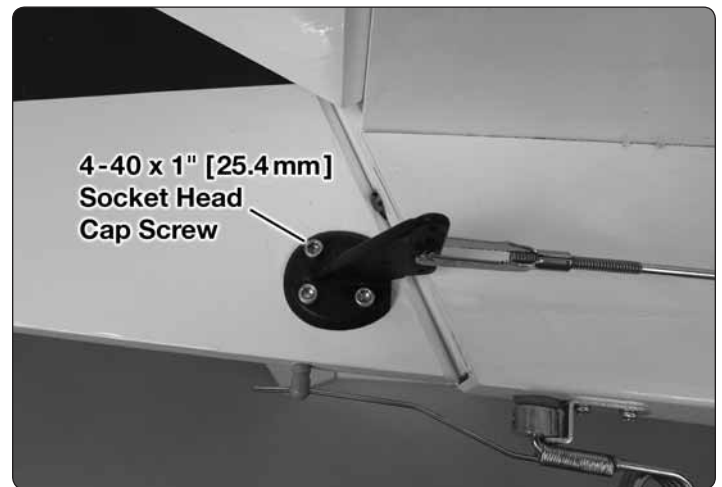

❑ 10. Attach the rudder control horn.

□ 11. Center the rudder and servo arm. Attach a 4-40 solder clevis to the rudder servo horn. Mark, cut and solder the clevis on the rudder pushrod following the same procedure used for the aileron pushrods.

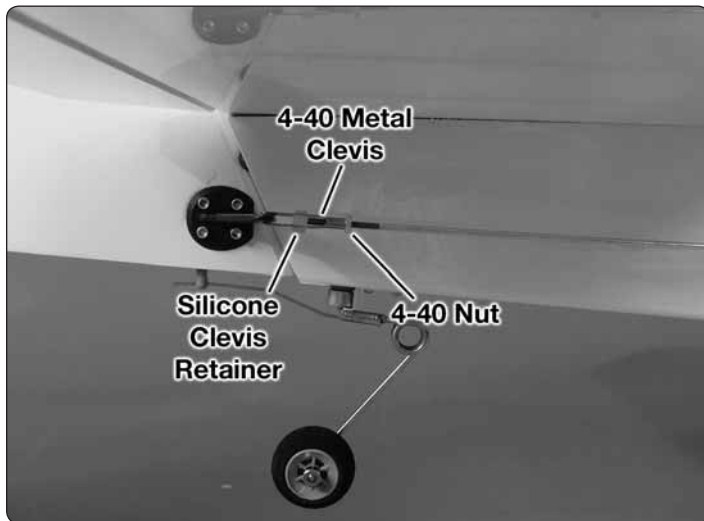
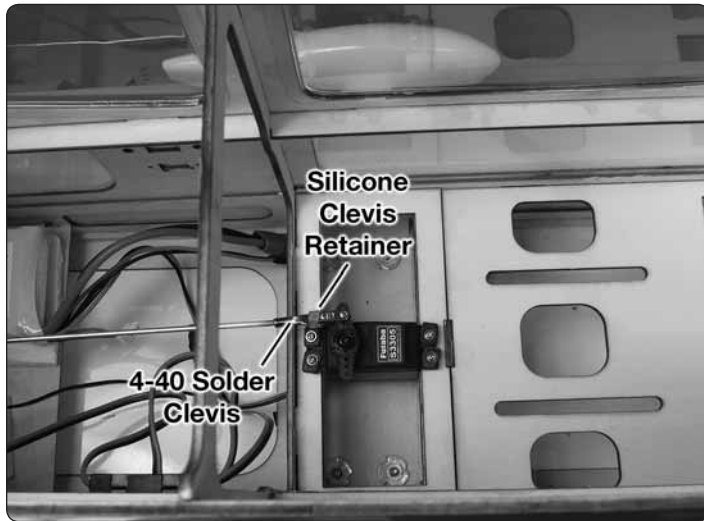

□ 12. Reinstall the rudder pushrod.

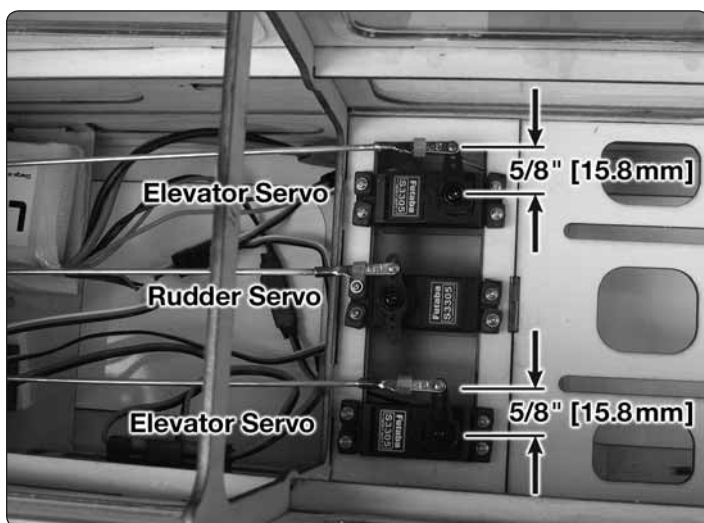

□ 13. Install the elevator pushrods following the same procedure used for the rudder.

Nose Gear Steering (for optional nose gear)

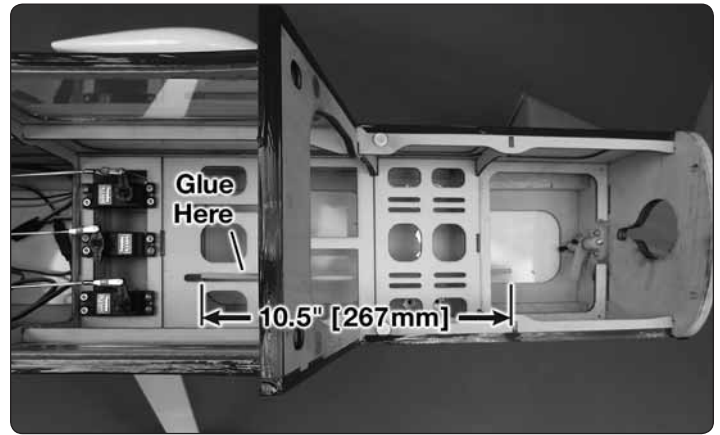

□ 1. Trim and glue the outer pushrod tube.

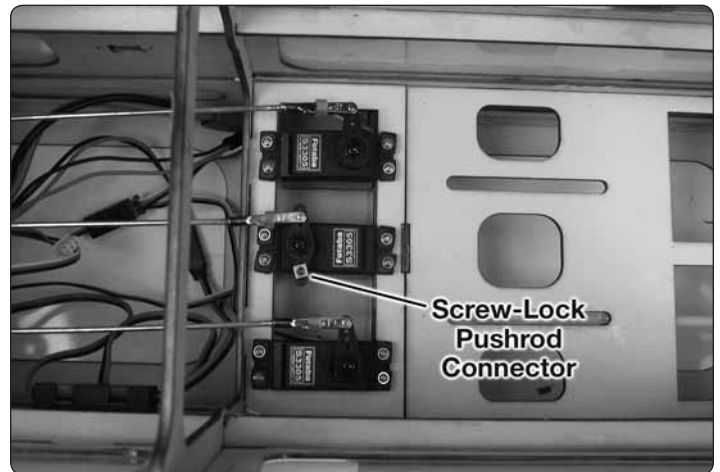
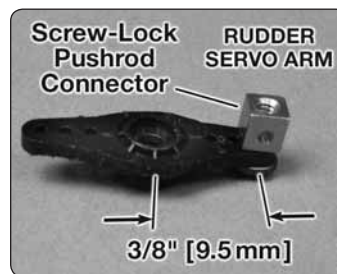

□ 2. Install the screw-lock pushrod connector on the rudder servo arm.

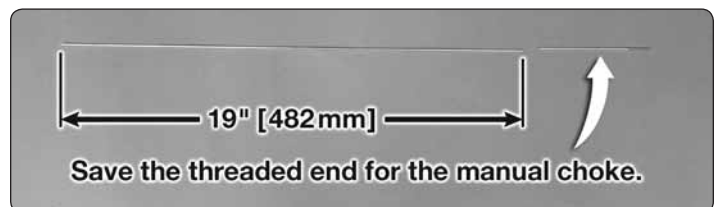

□ 3. Cut the 2-56 x 24" (61mm) pushrod.

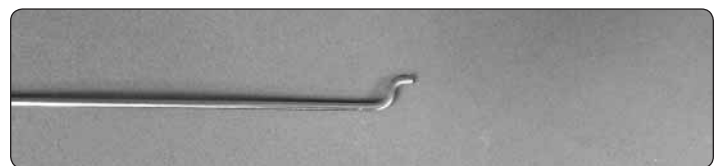

□ 4. Put a Z-bend in one end of the steering pushrod.

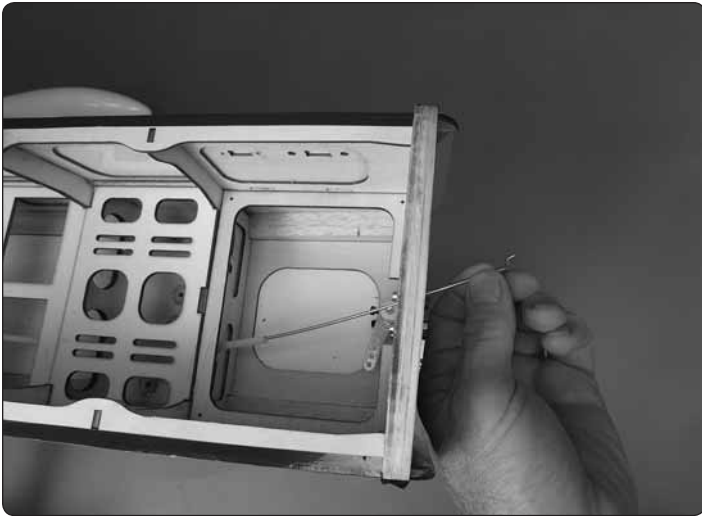

❑ 5. Insert the pushrod in the outer pushrod tube.

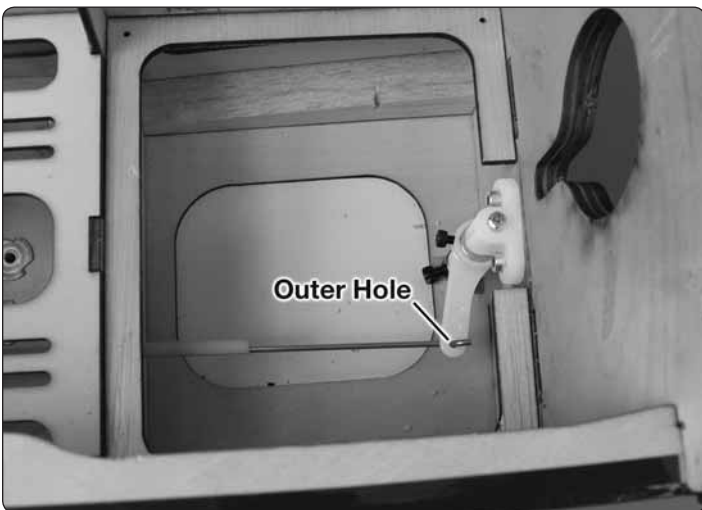

❑ 6. Remove the steering arm and insert the Z-bend into the outer hole. Re-attach the steering arm.

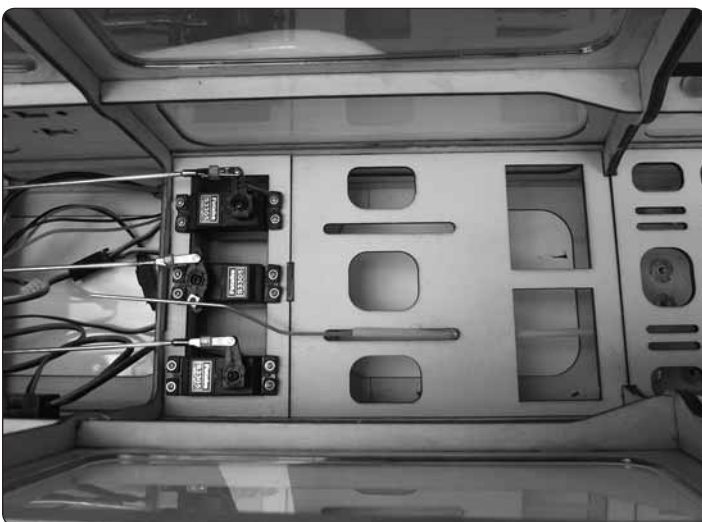

❑ 7. Bend the end of the pushrod so that it aligns with the pushrod connector.

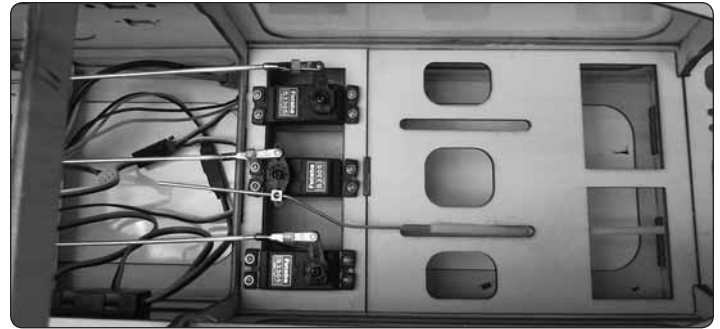

❑ 8. Remove the rudder servo arm, insert the steering pushrod in the pushrod connector and reinstall the servo arm.

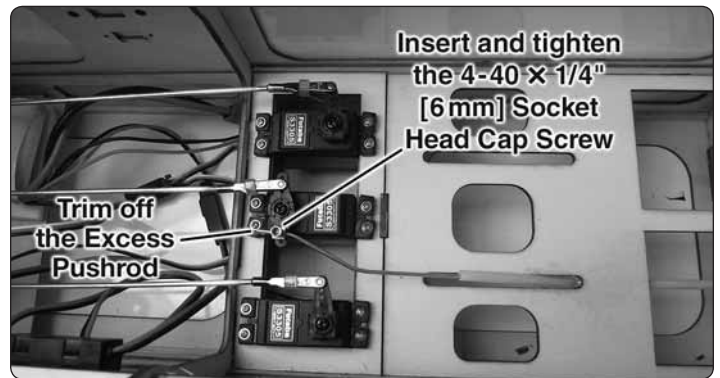

❑ 9. Center the nose wheel and tighten the screw.

Electric Motor Installation

Proceed to Engine and Tank Installation (page 23) if a gas engine will be installed.

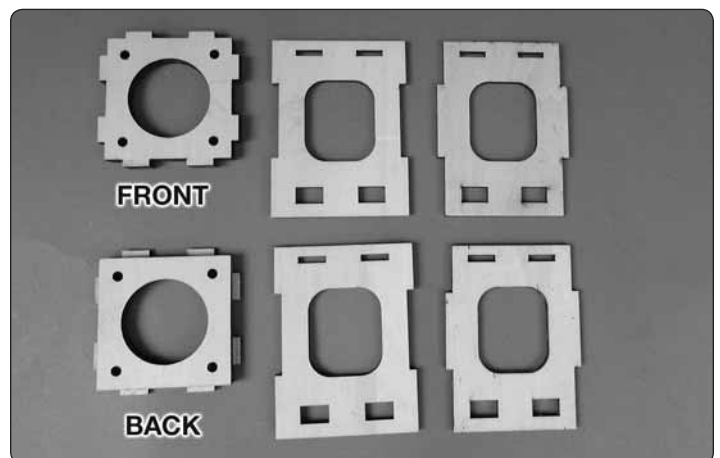
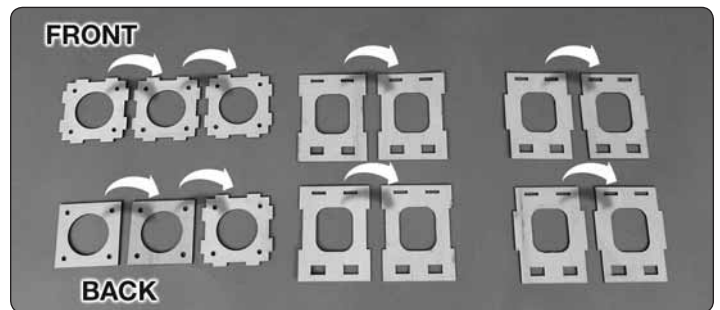

❑ 1. Use epoxy to glue the front, back, top, bottom and side plates of the motor box together.



2. Install the 8-32 blind nuts and secure with CA.

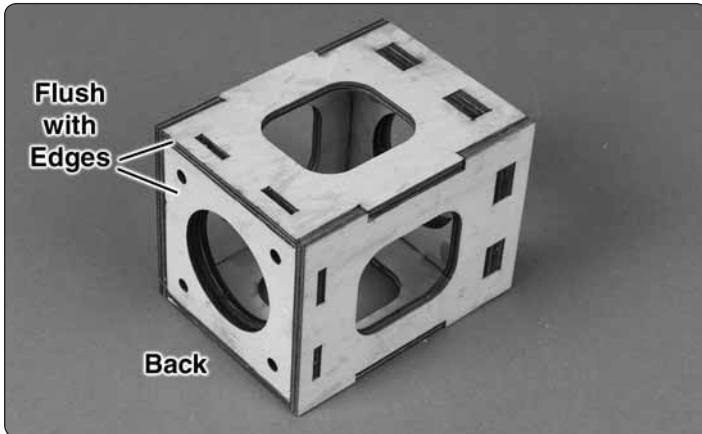

3. Use epoxy to glue the motor box together. The blind nuts go to the inside.



4. Drill the firewall.

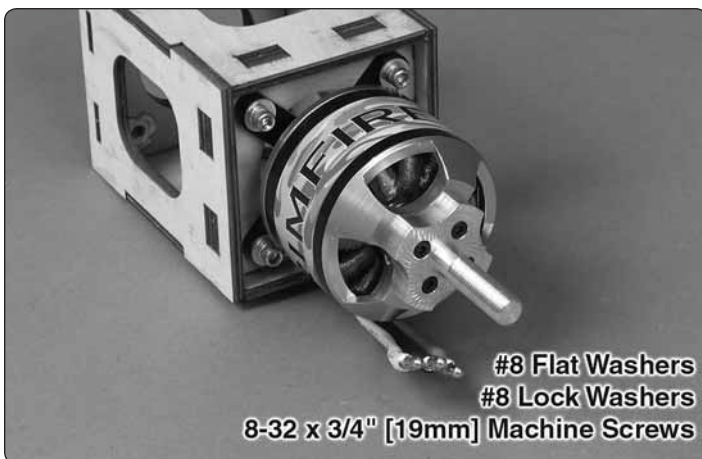

5. Install the RimFire 1.60 motor.



6. Mount the ESC. Connect the wires from the ESC to the motor wires.



7. Attach the motor box to the firewall.

8. Connect a 16" (406mm) servo extension to the ESC. Plug the ESC into the receiver.

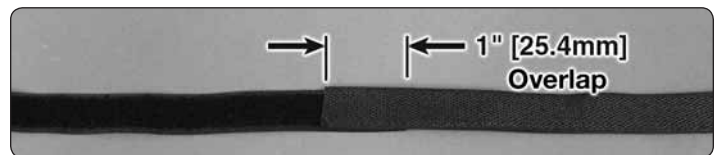

9. Make a battery strap from the supplied hook and loop material.



10. Install the battery strap on the battery tray.



- ❑ 11. Install the battery tray.
- ❑ 12. Check that the throttle is set to reverse if using a Futaba transmitter. Plug the motor batteries into the ESC. Check that the motor turns counter-clockwise. If not, switch two of the three motor wires.

Proceed to **Install the Cowl**.

Gas Engine Installation



- ❑ 1. Drill the firewall for your engine.

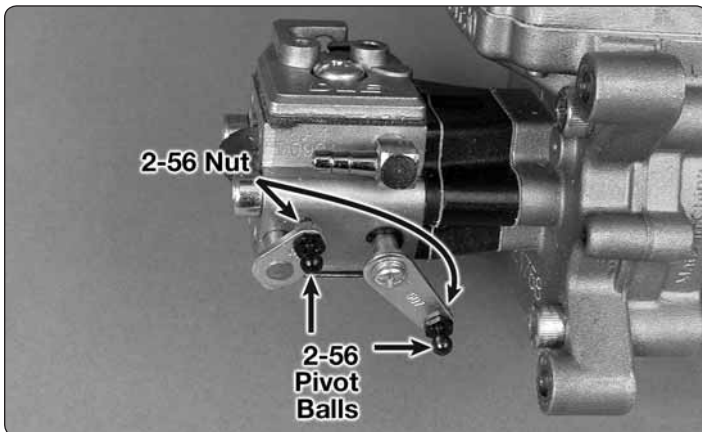

- ❑ 2. Install the pivot ball on the throttle and choke arm.



- ❑ 3. If installing one of the DLE engines, glue the three 1/8" (3.2mm) plywood engine standoffs together. Apply a thin coat of epoxy to fuelproof them. The O.S. GT33 uses the 2" (50.8mm) aluminum standoffs. (not included)



- ❑ 4. Temporarily mount the engine using the plywood standoff for the DLE engine or the metal standoff (not included) for the O.S. engine.

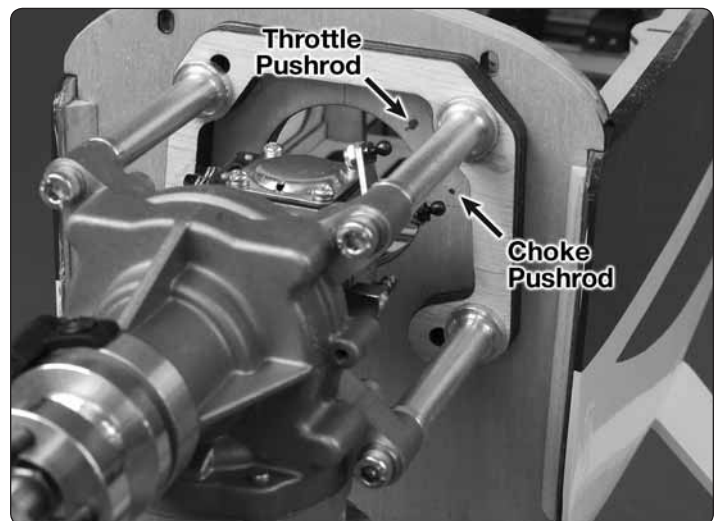

- ❑ 5. Mark the throttle and choke pushrod locations on the firewall.

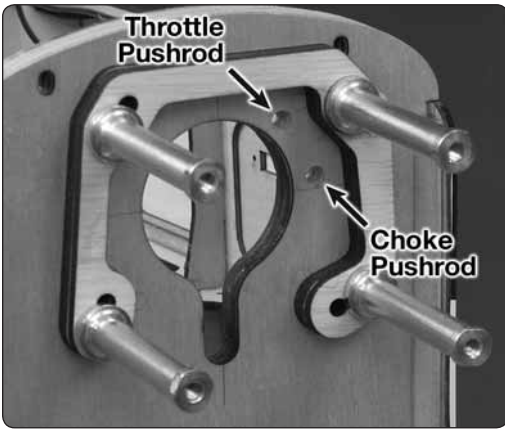

❑ 6. Remove the engine and drill 3/16" (4.8 mm) holes through the firewall for the throttle and choke.

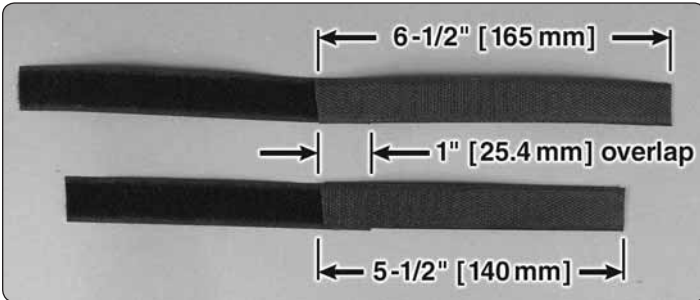

❑ 7. Make 2 straps from the supplied hook and loop material.



❑ 8. Install the ignition switch.

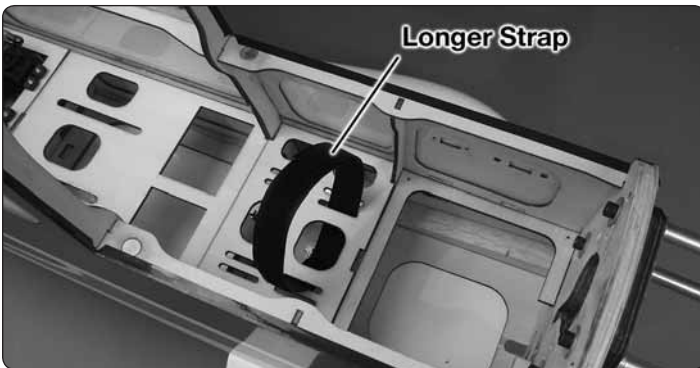

❑ 9. Install the fuel tank strap.



❑ 10. Install the ignition battery strap.

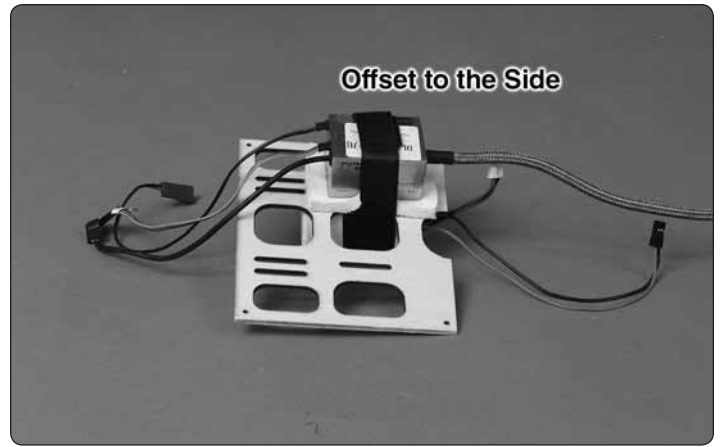

❑ 11. Wrap the ignition battery and ignition module in foam. Install the ignition battery below the tray and the ignition module on top of the tray. If the plane is set up with trike gear, the battery and ignition module may need to be offset to the side.

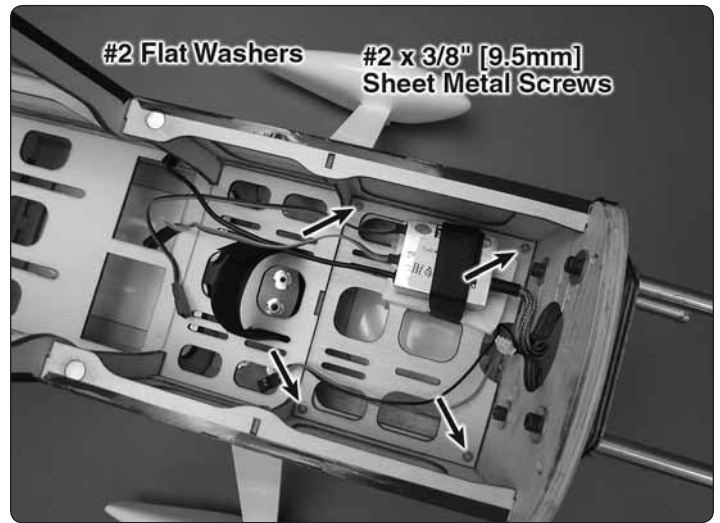

❑ 12. Install the tray. Connect the ignition battery and ignition module to this switch.

❑ 13. Reinstall the engine.

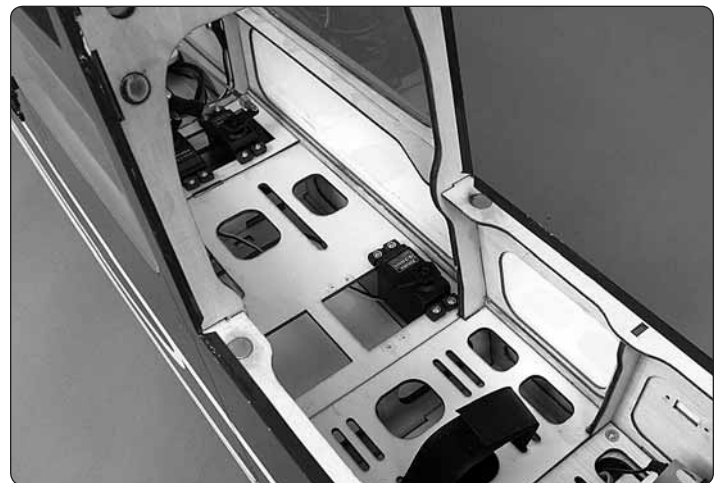

❑ 14. Install the throttle servo and 6" servo extension and plug it into the receiver.

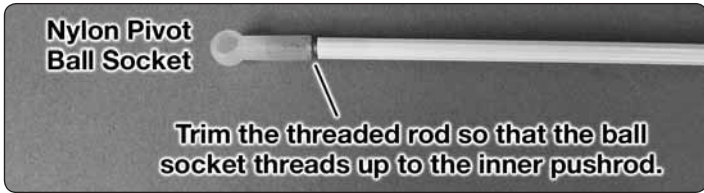

❑ 15. Assemble the throttle pushrod.

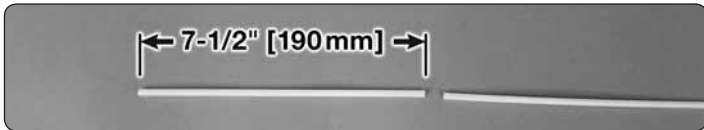

❑ 16. Cut the outer pushrod tube 7-1/2" [190mm] long.

❑ 17. Roughen the outer pushrod with sandpaper.

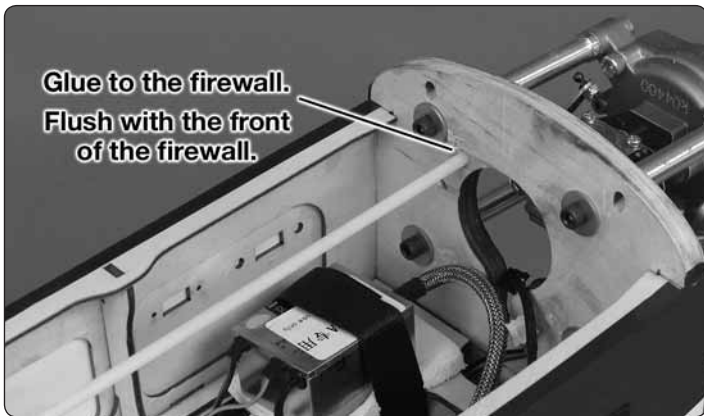

❑ 18. Install the outer pushrod.



❑ 19. Assemble the throttle clevis.

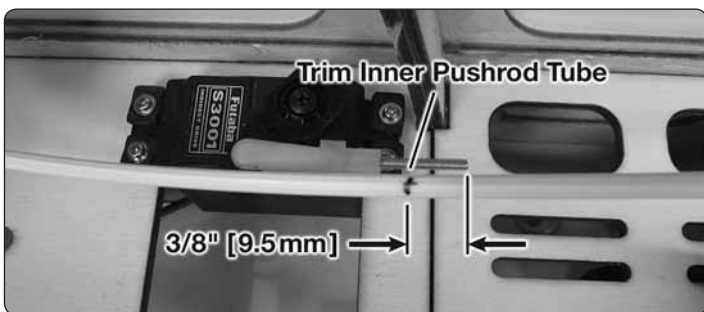

❑ 20. Install the nylon clevis on the throttle servo.

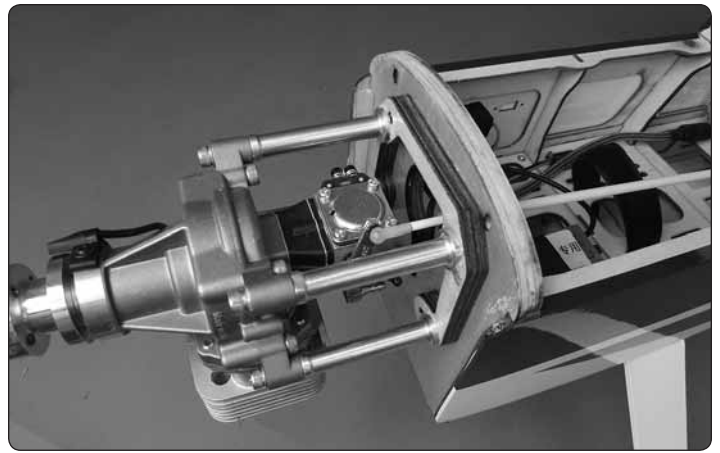

❑ 21. Snap the pivot ball socket on the throttle pivot ball. Switch on the radio system, and move the throttle stick to full throttle. Rotate the throttle arm to full throttle.



❑ 22. Slide the plywood outer pushrod support onto the outer pushrod.

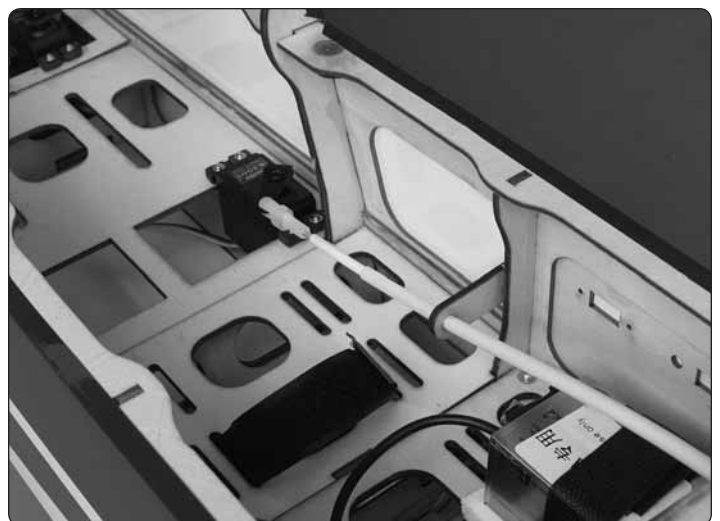

❑ 23. Thread the throttle clevis into the throttle pushrod. Glue the pushrod support to the fuselage. Adjust the throttle so that it opens fully. We set up the throttle so that at low throttle stick position the engine is at idle. We then set the throttle cut on a switch to fully close the throttle and stop the engine.

CHOKE CONTROL

The choke can be controlled manually or with a servo.

Manual Choke Control

Pivot
Ball
Socket

Remaining 2-56 metal
pushrod from Step 3 of
Optional Nose Gear

1. Assemble the choke pushrod.

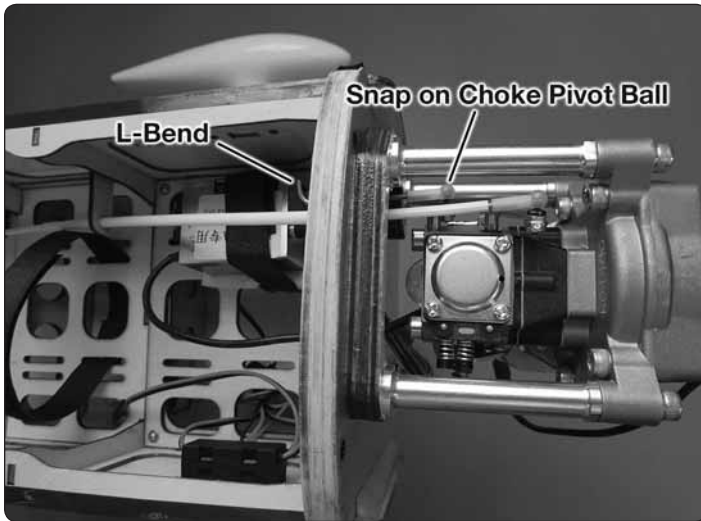

2. Install the manual choke pushrod.

Servo Controlled Choke



1. Install the servo controlled choke pushrod following the same procedure used to install the throttle pushrod.

Assemble the Fuel Tank

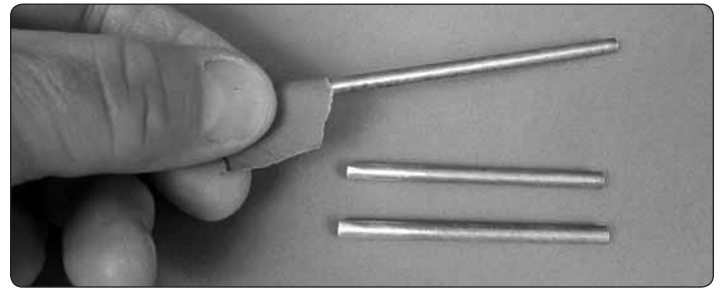

1. Clean both ends of the brass tubes with sandpaper.



2. Solder fuel line barbs onto one end of the brass tubes.

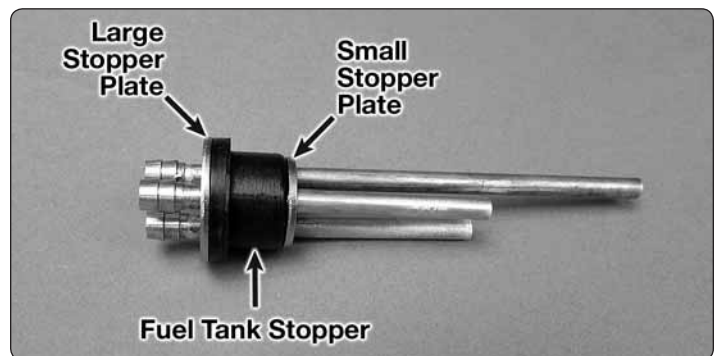

3. Insert the brass tubes in the fuel tank stopper and stopper plates.



4. Solder the barbs on the other end of the two shorter brass tubes.

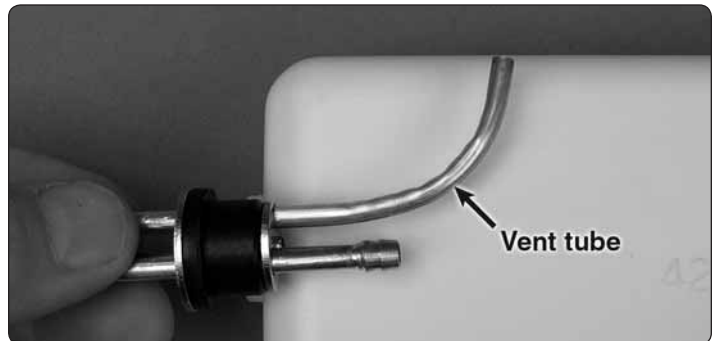

5. Bend the vent tube. The tube should not touch the tank.

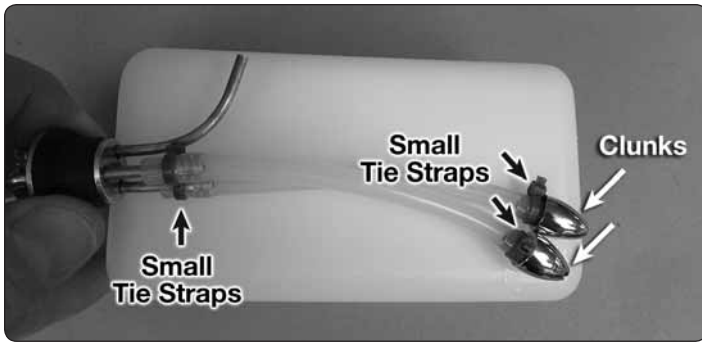

❑ 6. Install the two fuel pickup lines and clunks so they move freely.

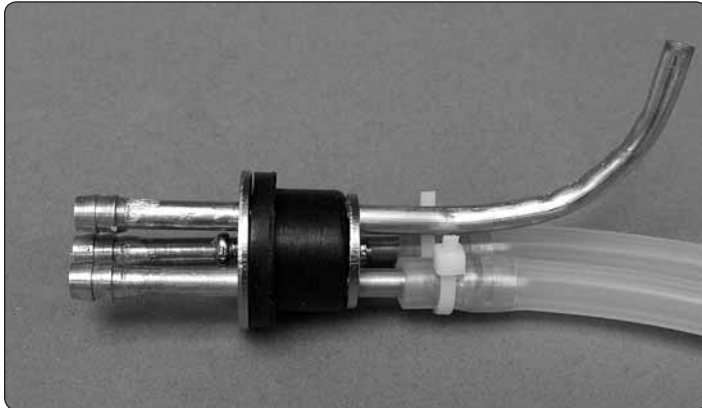

❑ 7. Loosely install the fuel tank stopper screw.

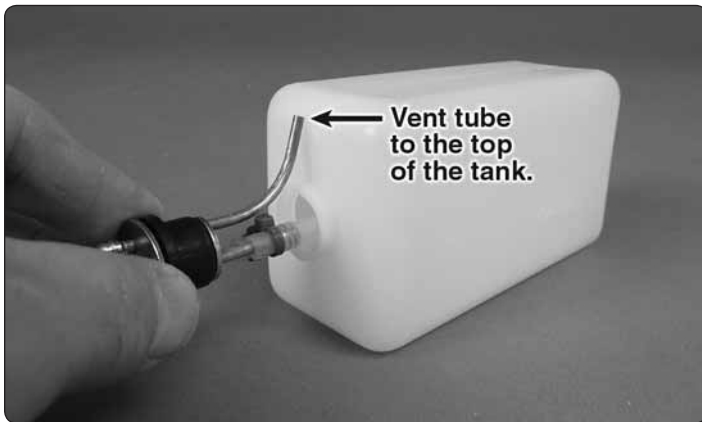

❑ 8. Secure the fuel tank stopper in the fuel tank. Mark the top of the tank.

Install the Fuel Tank

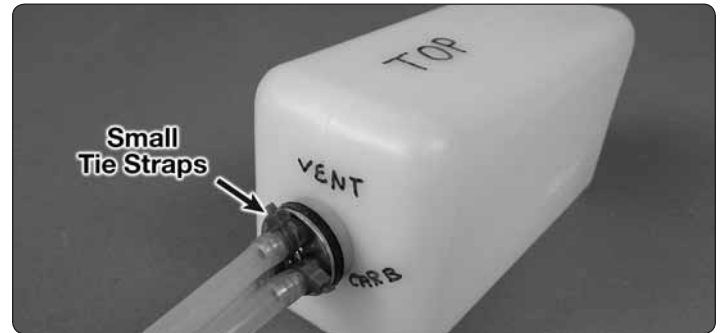

❑ 1. Install and mark the fuel lines: Vent, Carb and Fill.

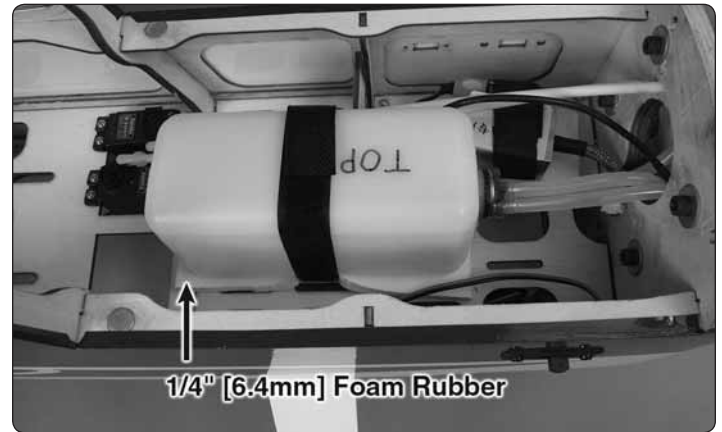

❑ 2. Secure the fuel tank in the fuselage.

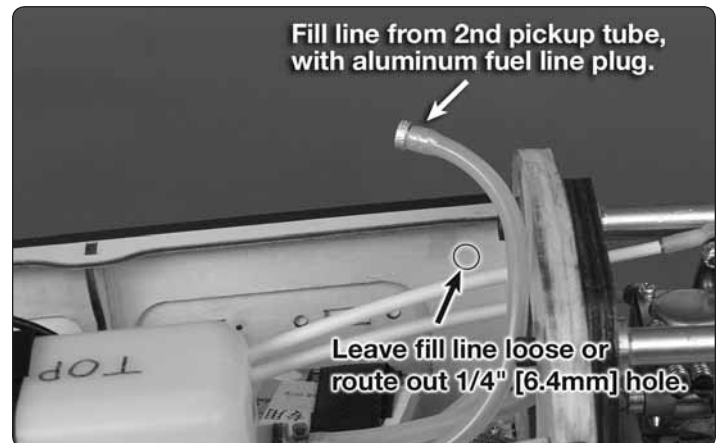
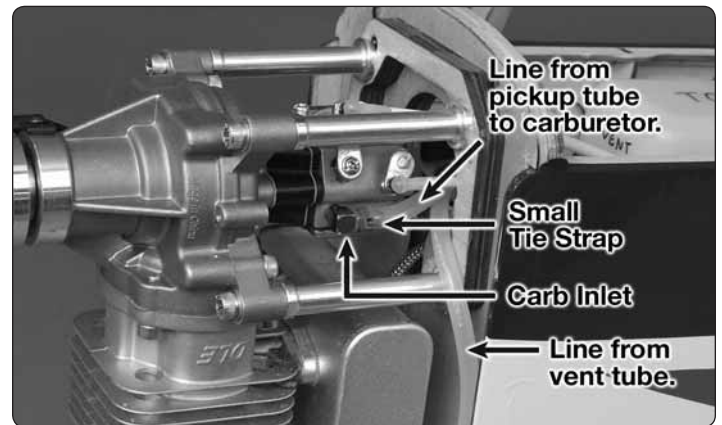

❑ 3. Route the fill line.

Install the Cowl

For the electric installation, skip to step 2.

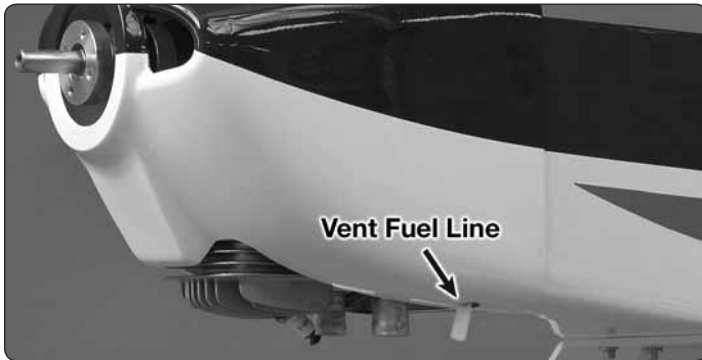

- ☐ 1. Trim the cowl to fit over the cylinder head and muffler.

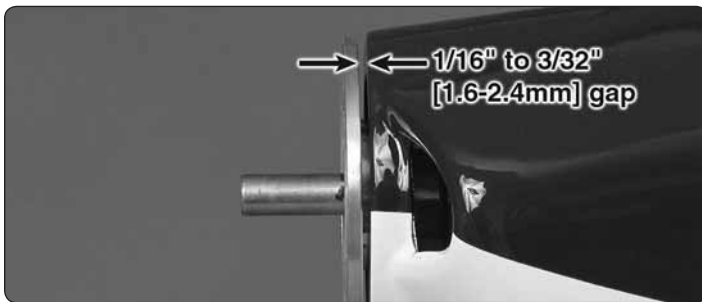
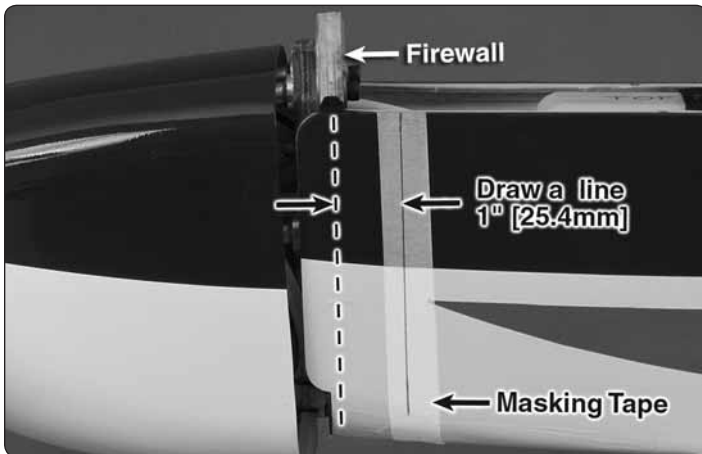

- ☐ 2. Position the cowl. The center of the spinner backplate will need to be enlarged to 25/64" (10mm for the DLE engines). The O.S. GT33 requires the brass insert in the backplate. The backplate fits on the RimFire 1.60.

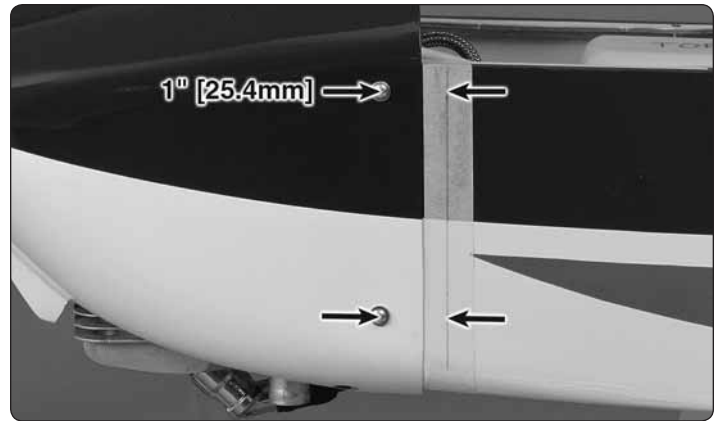

- ☐ 3. Drill 5/64" [2mm] pilot holes. Attach the cowl using #4 x 1/2" [12.7mm] sheet metal screws and #4 flat washers.



- ☐ 4. If an electric motor is installed, trim the covering from over the cooling air exit holes.

ASSEMBLE THE FORWARD HATCH

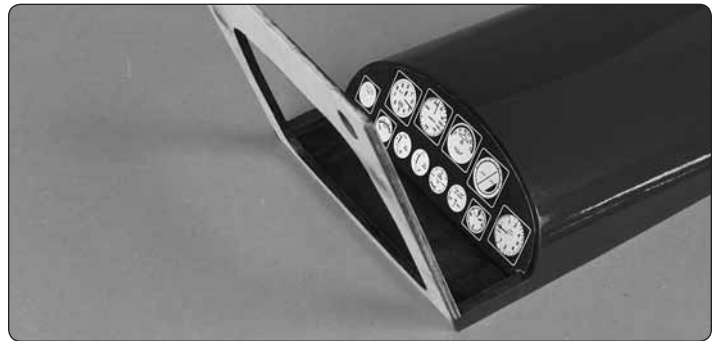

- ☐ 1. Install the die-cut instrument panel decal.

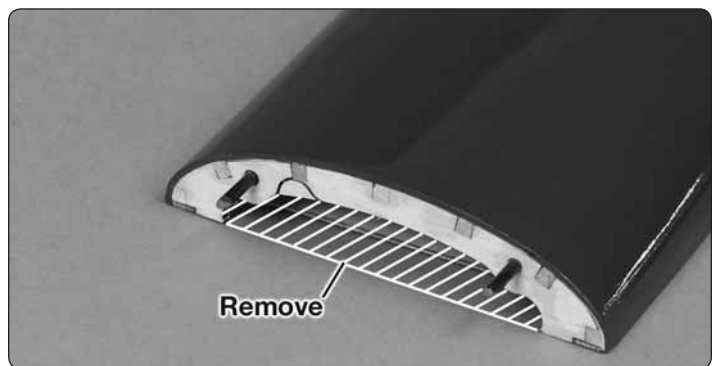

- ☐ 2. If the engine bolts hit the front, remove the plywood.



❑ 3. Position the hatch on the fuselage.

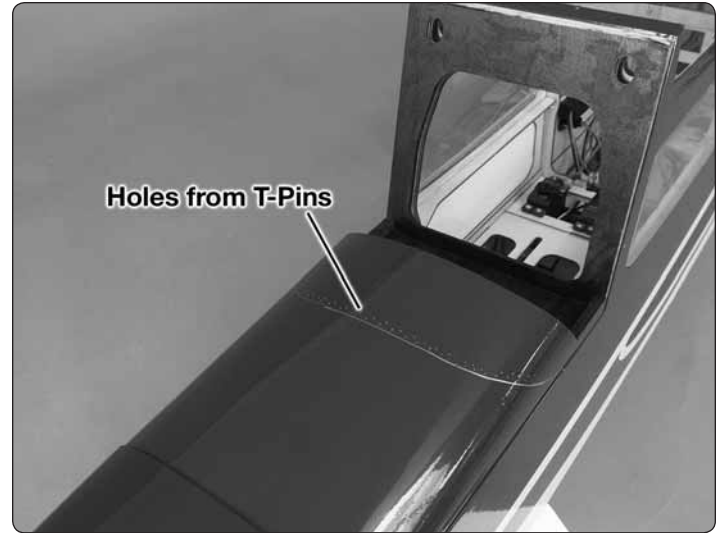

❑ 6. Use a T-pin to poke holes along the inside of the outline.



❑ 4. Test fit the windscreen on the hatch. Trim as necessary.

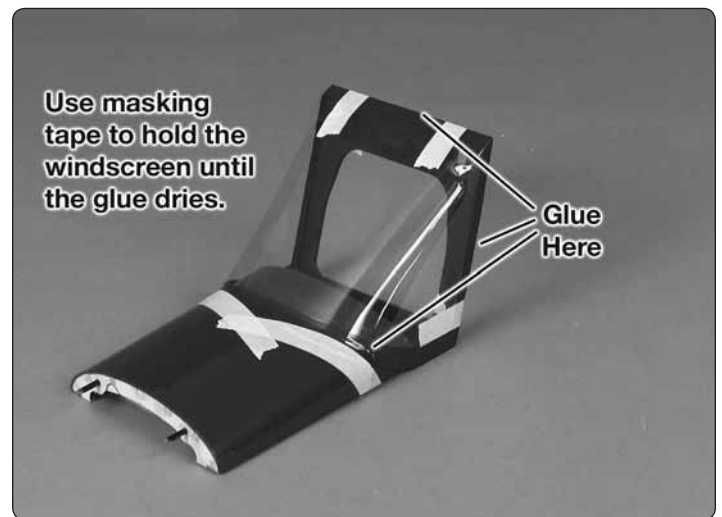

❑ 7. Wipe off the marks. Remove the hatch from the fuselage and glue the windscreen to the hatch with Canopy Glue.



❑ 5. Mark the outline of the windscreen.

Apply the Decals

1. The decals are die-cut from the factory.
2. Be certain the model is clean and free from oily fingerprints and dust. Prepare a dishpan or small bucket with a mixture of liquid dish soap and warm water—about 1/2 teaspoon of soap per gallon of water. Submerge one of the decals in the solution and peel off the paper backing. **NOTE:** Even though the decals have a “sticky-back” and are not the water transfer type, submersing them in soap & water allows accurate positioning and reduces air bubbles underneath.
3. Position decal on the model where desired. Holding the decal down, use a paper towel to wipe most of the water away.
4. Use a piece of soft balsa or something similar to squeegee remaining water from under the decal. Apply the rest of the decals the same way.

Please use the box top as a guide for the decal placement.

GET THE MODEL READY TO FLY

Check the Control Directions

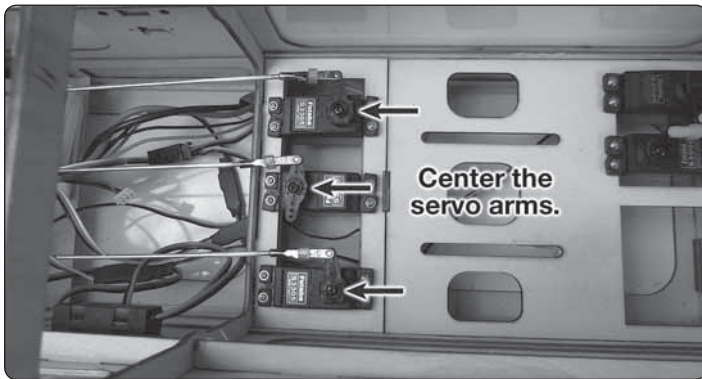
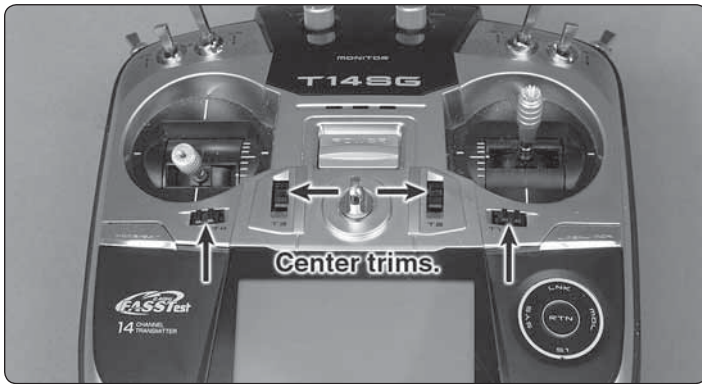

❑ 1. Switch on the transmitter and receiver.

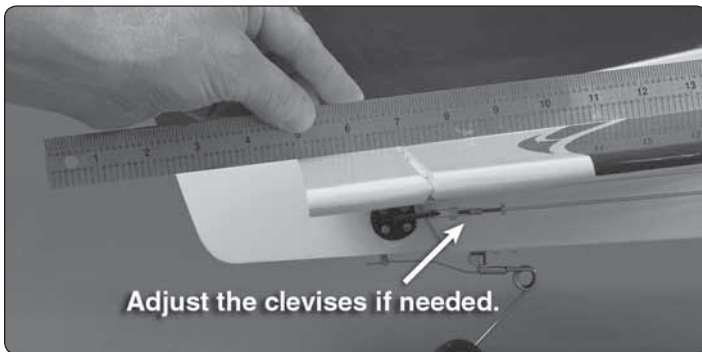

❑ 2. Center the control surfaces.

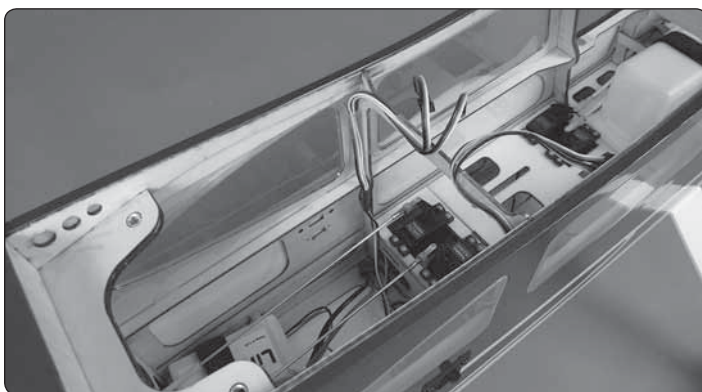

❑ 3. We plugged the Y-harnesses into the receiver for the aileron and flaps or the 300mm hub into the S.Bus port. These were then taped to the center former.

4-CHANNEL RADIO SET UP (STANDARD MODE 2)

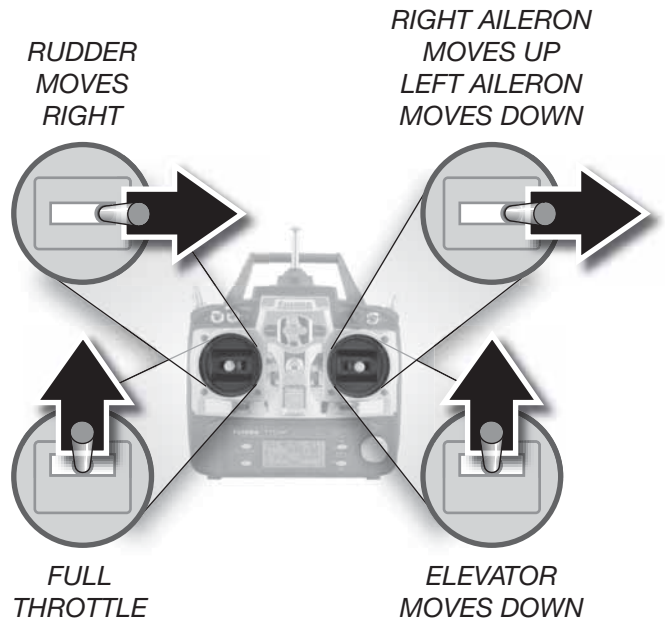

❑ 4. Make certain that the control surfaces and the carburetor respond in the correct direction as shown in the diagram. If any of the controls respond in the wrong direction, use the servo reversing in the transmitter to reverse the servos connected to those controls. Be certain the control surfaces have remained centered. Adjust if necessary.

Set the Control Throws

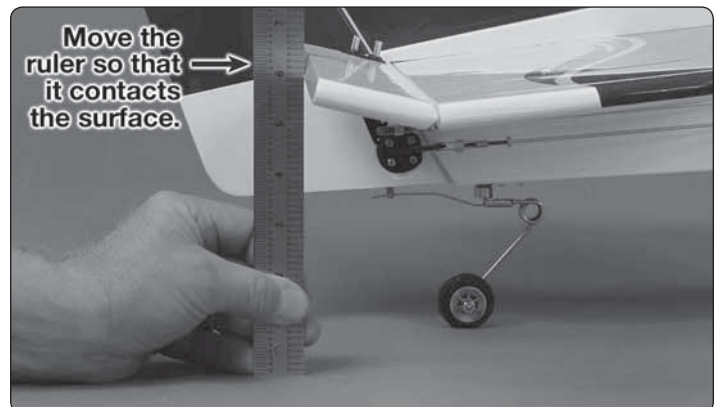
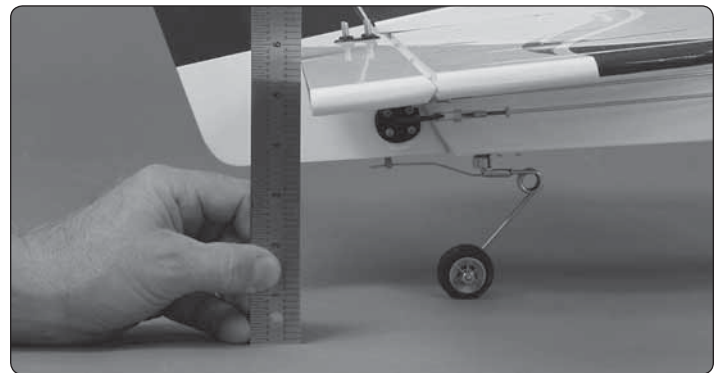

❑ 1. Hold a ruler against the widest part of the control surface and measure the high rate throw first.

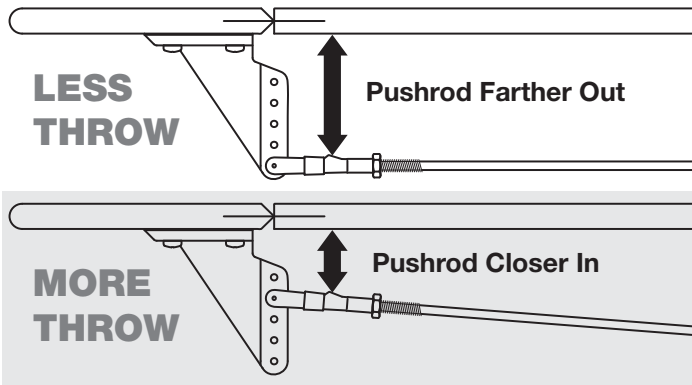

Pushrod Farther Out

Pushrod Closer In

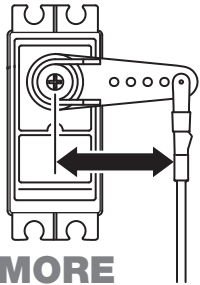

**MORE
THROW**

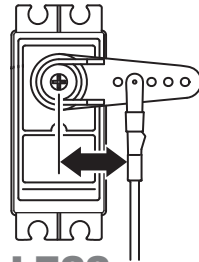

**LESS
THROW**

❑ 2. Adjust the location of the pushrod on the servo arm or on the control horn first. Then, use the endpoint adjustment in your transmitter to fine tune the throws.

❑ 3. Measure and set the **low rate** throws. Measure and set the high and low rate throws for the rest of the control surfaces the same way.

If your radio does not have dual rates, we recommend setting the throws at the high rate settings.

These are the recommended control surface throws:

	HIGH RATE		LOW RATE	
	Up	Down	Up	Down
ELEVATOR	3/4" [19mm] 21°	3/4" [19mm] 21°	1/2" [13mm] 14°	1/2" [13mm] 14°
RUDDER	1-3/8" [35mm] 15°	1-3/8" [35mm] 15°	1" [25mm] 11°	1" [25mm] 11°
AILERONS	3/4" [19mm] 17°	3/4" [19mm] 17°	1/2" [13mm] 12°	1/2" [13mm] 12°
FLAPS	Down 1-1/4" [32mm] 29°			

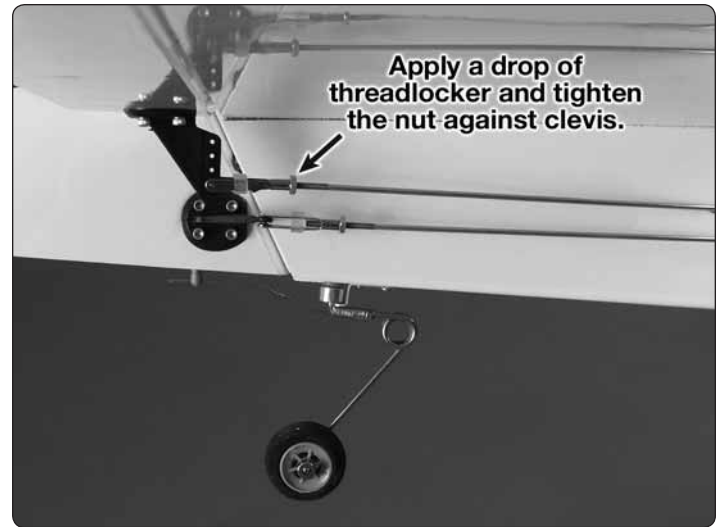

❑ 4. Once the throws are set, apply a drop of threadlocker to the threads and tighten the 4-40 nuts against the clevises. Slide the silicone retainers over the clevises.



IMPORTANT: Now that you have the throws set, be sure to set the failsafe on the radio. The failsafe must stop the motor if the signal is lost.

Install the Propeller

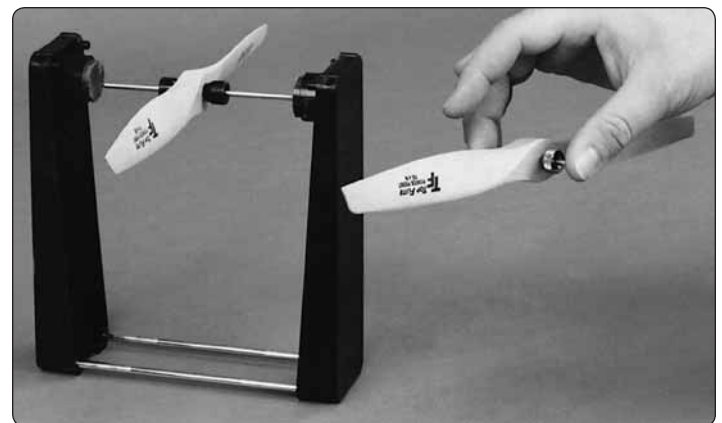

❑ 1. Balance the propeller.

Balance the Model Laterally

ELECTRIC ONLY: Install the flight batteries, but **do not** plug the batteries into the ESC.

❑ 1. With the wing level, have an assistant help you lift the model by the engine propeller shaft and the bottom of the fuse under the TE of the fin. Do this several times.

❑ 2. If one wing always drops when you lift the model, it means that side is heavy. Balance the airplane by adding weight to the other wing tip. **An airplane that has been laterally balanced will track better in loops and other maneuvers.**

Balance the Model (C.G.)

DO NOT OVERLOOK THIS IMPORTANT PROCEDURE.

A model that is not properly balanced may be unstable and possibly unflyable.

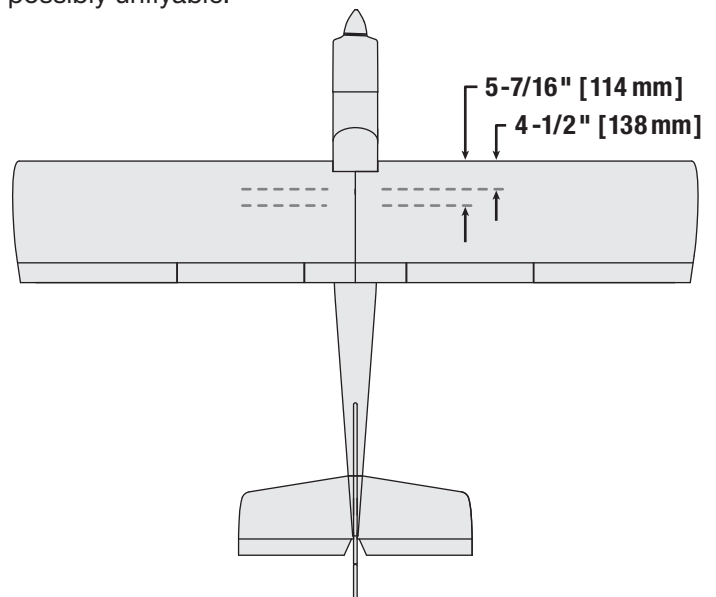

❑ 1. Mark the C.G. range.



❑ 2. With the plane **ready to fly**, with an empty fuel tank or motor batteries installed, use a Great Planes C.G. Machine or apply narrow (1/16" [2mm]) strips of tape at the front and rear



❑ 2. Install the propeller. Drill holes through the propeller if necessary.

ELECTRIC ONLY: Install the spinner adapter (GPMQ4584) before installing the spinner cone.



❑ 3. Install the spinner cone.



❑ 4. Install the plastic floor.

C.G. locations so you will be able to feel them when lifting the model with your fingers to check the C.G. location. **Do not at any time balance the model outside this C.G. range.**

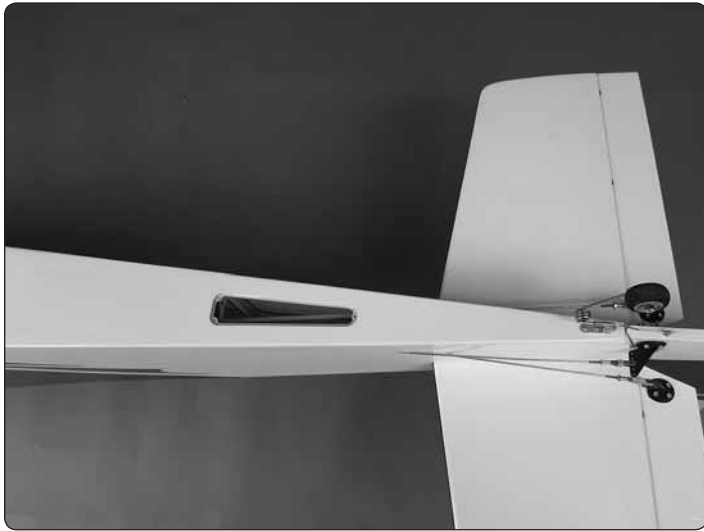

3. Use Great Planes “stick on” weight (GPMQ4485) to balance the plane. Place incrementally increasing amounts of weight on the bottom of the fuselage over the location where it would be mounted inside until the model balances. A good place to add stick-on nose weight is to the firewall. Do not attach weight to the cowl—this will cause stress on the cowl and could cause the cowl to crack at the screw holes. Once you have determined if additional weight needs to be installed, permanently attach the weight with glue or screws. If tail weight is needed, remove the covering from over the weight hatch, install the weight and install the hatch cover.

4. **IMPORTANT:** If you found it necessary to add any weight, recheck the C.G. after the weight has been installed.

PREFLIGHT

Identify Your Model

You should always have your name, address, telephone number and AMA number on or inside your model. It is **required** at all AMA R/C club flying sites and AMA sanctioned

flying events. Fill out the identification tag on the decal sheet and place it on or inside your model.

Charge the Batteries

Always charge your transmitter and receiver batteries the night before you go flying, and at other times as recommended by the radio manufacturer.

CAUTION: Unless the instructions that came with your radio system state differently, the **initial** charge on **new** transmitter and NiMH receiver batteries should be done for 15 hours **using the slow-charger that came with the radio system.** This will “condition” the batteries so that the next charge may be done using the fast-charger of your choice. If the initial charge is done with a fast-charger the batteries may not reach their full capacity and you may be flying with batteries that are only partially charged.

Ground Check and Range Check

Make sure the engine idles reliably, transitions smoothly and maintains full power indefinitely. Shut the engine off and inspect the model closely, making sure all fasteners, pushrods and connections have remained tight and the hinges are secure. Follow the radio manufacturer’s instructions to ground check the operational range of your radio before the first flight of the day. This should be done once with the engine off and once with the engine running at various speeds. If the control surfaces do not respond correctly, **do not fly!** Find and correct the problem first. Look for loose servo connections or broken wires, corroded wires on old servo connectors, poor solder joints in your battery pack or a defective battery cell.

ENGINE SAFETY PRECAUTIONS

Failure to follow these safety precautions may result in severe injury to yourself and others.

- Keep all engine fuel in a safe place, away from high heat, sparks or flames, as fuel is very flammable. Do not smoke near the engine or fuel; and remember that engine exhaust gives off a great deal of deadly carbon monoxide. Therefore **do not run the engine in a closed room or garage.**
- Get help from an experienced pilot when learning to operate engines.
- Use safety glasses when starting or running engines.
- Use a “chicken stick” or electric starter to start the engine. If you do flip the propeller with your fingers, wear a heavy leather glove, such as a welder’s glove. When hand starting gas engines, if the engine should backfire, the large prop can cause severe injury to your hand and fingers.
- Do not run the engine in an area of loose gravel or sand; the propeller may throw such material in your face or eyes.
- Keep your face and body as well as all spectators away from the plane of rotation of the propeller as you start and run the engine.

- Keep these items away from the prop: loose clothing, shirt sleeves, ties, scarfs, long hair or loose objects such as pencils or screwdrivers that may fall out of shirt or jacket pockets into the prop.
- Stop the engine before making any engine adjustments.
- The engine and muffler get hot! Do not touch them during or right after operation. Make sure fuel lines are in good condition so fuel will not leak onto a hot engine, causing a fire.
- To stop a gasoline powered engine an on/off switch must be connected to the engine ignition. Do not throw anything into the propeller of a running engine.

ELECTRIC MOTOR SAFETY PRECAUTIONS

- Read and follow the battery and ESC instructions carefully for correct use and operation.
- The motor gets HOT! Do not touch it during or right after operation.
- When working on your plane, remove the propeller if the motor batteries will be connected.
- Always remove the motor batteries when charging.
- Follow the charging instructions included with your charger for charging LiPo batteries. LiPo batteries can cause serious damage if misused.
- Once the motor batteries are connected, the electric motor can start at any time. Make sure the fail safe is set on your radio to prevent the motor from starting if the signal is lost.
- **ALWAYS** unplug the motor batteries first.
- **NEVER** switch off the transmitter with the motor batteries plugged in.
- **WARNING:** Read the entire instruction sheet included with your motor batteries. Failure to follow the instructions could cause permanent damage to the battery and its surroundings and cause bodily harm!
- **ONLY** use a LiPo approved charger.
- **NEVER** use a NiCd/NiMH peak charger to charge a LiPo battery.
- **NEVER** charge in excess of 4.20V per cell.
- **ONLY** charge through the “charge” lead.
- **NEVER** charge through the “discharge” lead.
- **NEVER** charge at currents greater than 1C unless the battery is rated for a higher charge rate.
- **ALWAYS** set the charger’s output volts to match the battery volts.
- **ALWAYS** charge a LiPo battery in a fireproof location.
- **NEVER** trickle charge a LiPo battery.
- **NEVER** allow the battery temperature to exceed 150° F (65° C).
- **NEVER** disassemble or modify the pack wiring in any way or puncture the cells.
- **NEVER** discharge below 2.7V per cell.

- **NEVER** place the battery or charger on combustible materials or leave it unattended during charge or discharge.
- **ALWAYS** KEEP OUT OF THE REACH OF CHILDREN.
- **NEVER** charge the battery in the plane.
- **ALWAYS** remove the battery from the plane after a crash. Set it aside in a safe location for at least 20 minutes. If the battery is damaged in the crash it could catch fire.
- If the battery starts to swell, quickly move the battery to a safe location, preferably outside. Place it in a bucket, covering the battery with sand. Never use water to try and put out a LiPo fire.

AMA SAFETY CODE (excerpts)

Read and abide by the following excerpts from the Academy of Model Aeronautics Safety Code. For the complete Safety Code refer to Model Aviation magazine, the AMA web site or the Code that came with your AMA license.

General

- 1) I will not fly my model aircraft in sanctioned events, air shows, or model flying demonstrations until it has been proven to be airworthy by having been previously, successfully flight tested.
- 2) I will not fly my model aircraft higher than approximately 400 feet within 3 miles of an airport without notifying the airport operator. I will give right-of-way and avoid flying in the proximity of full-scale aircraft. Where necessary, an observer shall be utilized to supervise flying to avoid having models fly in the proximity of full-scale aircraft.
- 3) Where established, I will abide by the safety rules for the flying site I use, and I will not willfully and deliberately fly my models in a careless, reckless and/or dangerous manner.
- 5) I will not fly my model unless it is identified with my name and address or AMA number, on or in the model. Note: This does not apply to models while being flown indoors.
- 7) I will not operate models with pyrotechnics (any device that explodes, burns, or propels a projectile of any kind).

Radio Control

- 1) I will have completed a successful radio equipment ground check before the first flight of a new or repaired model.
- 2) I will not fly my model aircraft in the presence of spectators until I become a qualified flier, unless assisted by an experienced helper.
- 3) At all flying sites a straight or curved line(s) must be established in front of which all flying takes place with the other side for spectators. Only personnel involved with flying the aircraft are allowed at or in the front of the flight line. Intentional flying behind the flight line is prohibited.
- 4) I will operate my model using only radio control frequencies currently allowed by the Federal Communications Commission.

5) **I will not knowingly operate my model within three miles of any pre-existing flying site except in accordance with the frequency sharing agreement listed** [in the complete AMA Safety Code].

9) Under no circumstances may a pilot or other person touch a powered model in flight; **nor should any part of the model other than the landing gear, intentionally touch the ground, except while landing.**

FLYING

The Avistar 30cc ARF is a great-flying model that flies smoothly and predictably. However, it does not possess the self-recovery characteristics of a primary R/C trainer and should be flown only by beginners with an experienced R/C pilot or instructor.

Fuel Mixture Adjustments

A fully cowled engine may run at a higher temperature than an un-cowled engine. For this reason, the fuel mixture should be richened so the engine runs at about 200 rpm below peak speed. By running the engine slightly rich, you will help prevent dead-stick landings caused by overheating.

CAUTION (THIS APPLIES TO ALL R/C AIRPLANES):

If, while flying, you notice an alarming or unusual sound such as a low-pitched “buzz,” this may indicate control surface flutter. Flutter occurs when a control surface (such as an aileron or elevator) or a flying surface (such as a wing or stab) rapidly vibrates up and down (thus causing the noise). In extreme cases, if not detected immediately, flutter can actually cause the control surface to detach or the flying surface to fail, thus causing loss of control followed by an impending crash. If flutter is detected, slow the model **immediately** and land as soon as safely possible. Identify which surface fluttered (so the problem may be resolved) by checking all the servo grommets for deterioration or signs of vibration. Make certain all pushrod linkages are secure and free of play. If it fluttered once, under similar circumstances it will probably flutter again unless the problem is fixed. Some things which can cause flutter are; Excessive hinge gap; Not mounting control horns solidly; Poor fit of clevis pin in horn; Side-play of wire pushrods caused by large bends; Excessive free play in servo gears; Insecure servo mounting; and one of the most prevalent causes of flutter; Flying an over-powered model at excessive speeds.

Takeoff

Before taking off, see how the model handles on the ground by doing a few practice runs at **low speeds** on the runway. Hold “up” elevator to keep the tail wheel on the ground. If necessary, adjust the tail wheel so the model will roll straight down the runway.

Remember to takeoff directly into the wind. When you’re ready, point the model straight down the runway, hold a bit of up elevator to keep the tail on the ground to maintain tail wheel steering (on a tail dragger model), then gradually advance the throttle. As the model gains speed, decrease up elevator allowing the tail to come off the ground. One of the most important things to remember with a tail dragger

is to always be ready to apply **right** rudder to counteract engine torque. Gain as much speed as your runway and flying site will practically allow before gently applying up elevator, lifting the model into the air. At this moment it is likely that you will need to apply more right rudder to counteract engine torque. Be smooth on the elevator stick, allowing the model to establish a **gentle** climb to a safe altitude before turning into the traffic pattern.

Flight

It is a good idea to have an assistant on the flight line with you to keep an eye on other traffic. Take it easy with the Avistar 30cc ARF for the first few flights, gradually getting acquainted with it as you gain confidence. We have found that the high rate rudder throw is only needed for ground handling. Low rate rudder is best for flying. Adjust the trims to maintain straight and level flight. After flying around for a while, and while still at a safe altitude with plenty of fuel, practice slow flight and execute practice landing approaches by reducing the throttle and lowering the flaps to see how the model handles at slower speeds. Add power to see how she climbs as well. Continue to fly around, executing various maneuvers and making mental notes of what trim or C.G. changes may be required to fine tune the model so it flies the way you like. Mind your fuel level, but use this first flight to become familiar with your model before landing.

With the electric setup, if using the recommended 5000 mAh LiPo batteries, set your transmitter timer for 6-minutes for the first flight. After you land, check the capacity of the batteries and adjust the timer as needed. With good throttle management, 10 minute flights or more are possible,

Landing

The Avistar 30cc lands similar to a .60 size sport plane. It does not require flaps to land, but the flaps will allow the plane to land slower and are great practice for the pilot that has never used flaps. Flaps increase lift and drag, thus reducing rollout after touchdown (not as much of a factor on grass runways). To initiate a landing approach, lower the throttle while on the downwind leg. If using flaps, allow the model to slow before extending them. Continue to lose altitude, but maintain airspeed by keeping the nose down as you turn onto the crosswind leg. Make your final turn toward the runway (into the wind) keeping the nose down to maintain airspeed and control. If using flaps, keep a few additional “clicks” of power so the model doesn’t slow too much. Level the attitude when the model reaches the runway threshold, modulating the throttle as necessary to maintain your glide path and airspeed. If you are going to overshoot, smoothly advance the throttle (always ready on the right rudder to counteract torque) and retract the flaps when enough airspeed is gained. Climb out to make another attempt. When the model is a foot or so off the deck, smoothly increase up elevator until it gently touches down. Once the model is on the runway and has lost flying speed, hold up elevator to place the tail on the ground, regaining tail wheel control.

NOTE: If ever the occasion arises when a dead-stick landing must be performed, do not extend the flaps until **certain** the

model will be able to reach the landing zone (on dead-stick landings it is common to land with no flaps at all). Without engine power, flaps can unexpectedly reduce the model's range, thus causing you to come up short of the field.

Have a goal or flight plan in mind each time you fly. This may be learning or improving a maneuver or learning how the model behaves at certain speeds and control rates. Every

maneuver should be deliberate, not impulsive. A flight plan reduces the chances of crashing your model because of poor planning and impulsive moves.

Have a ball! But always stay in control and fly in a safe manner.

GOOD LUCK AND GREAT FLYING!

PARTS LIST

QTY.	DESCRIPTION	QTY.	DESCRIPTION
1	Fuel Tank stopper	7	4-40 metal clevis
1	Fuel tank stopper screw	23	#4 x 1/2" sheet metal screw
1	Fuel tank stopper plate large	7	4-40 nut
1	Fuel tank stopper plate small	16	silicone clevis keeper
2	clunks	2	3/16" axle
1	Long brass tube	2	3/16" axle nut
2	Short brass tube	4	3/16" Wheel collar
8	small nylon tie straps	4	6-32 x 1/4" socket head cap screw
1	Spinner backplate	4	4-40 x 1/2" machine screw
1	Spinner bolt	11	#4 flat washer
1	Spinner backplate adapter	4	#4 lock washer
1	Plastic floor	8	6-32 x 3/4" socket head cap screw
3	16.5" outer pushrod tube	8	#6 flat washer
2	Hook and loop material 300mm	8	#6 lock washer
1	Tail gear bracket	8	8-32 Blind nuts
1	Tail gear spacer	4	8-32 x 3/4" socket head cap screw
1	Tail gear spacer set screw	4	8-32 x 1" socket head cap screw
1	Tail gear bushing	8	#8 flat washer
1	Tail gear wire support	8	#8 Lock washer
1	Tail gear wheel collar	12	4-40 x 1" socket head cap screw
1	Tail gear wheel collar set screw	3	4-40 x 48" threaded rod
7	Extra large control horns	1	2-56 x 36" theaded pushrod
3	Control horn back plates	2	1/4-20 x 2" nylon wing bolt
3	Plywood engine mount spacers	1	aluminum fuel plug
2	10 x 30mm Wing dowels	11	#2 x 3/8" sheet metal screw
1	8 x 30mm wing alignment dowel	11	#2 flat washers
4	Plywood motor mount top and bottom	1	Brass screw lock connector
4	Plywood motor mount sides	1	screw lock retainer
4	Plywood motor mount ends w/tabs	1	4-40 x 1/4" socket head cap screw
2	Plywood motor mount ends no tabs	1	white inner pushrod tube
1	Plywood outer pushrod tube support long	4	2-56 x 1" threaded stud
1	Plywood outer pushrod tube support short	2	2-56 pivot balls
1	Fuselage weight cover	2	2-56 nut
7	4-40 Solder clevis	2	Nylon pivot ball sockets
4	4-40 x 6" metal pushrod	2	nylon clevis

